

UNI12 BCD/U

SURFACE AND RECESSED PROFILE

PROFIL WPUSTOWO-NAWIERZCHNIOWY

- 7 diffusers to choose from
- increased radiation – it is possible to use a stronger LED strip
- maximum LED strip width: 12 mm

- 7 kloszy do wyboru
- zwiększona radiacja – możliwość zastosowania mocniejszej taśmy LED
- maksymalna szerokość taśmy LED: 12 mm



SIMILAR IN THE OFFER / PODOBNE W OFERCIE



DEEP10
BC/UX



GROOVE10
BC/UX



SURFACE10
BC/UX



FLOOR12
K/U



UNI-TILE12
90 deg C



UNI-TILE12
180 deg C



UNI-TILE12
270 deg C



B slide cover
klosz B wsuwany

C click cover
klosz C klik

C lens cover
klosz C soczewka

D click cover
klosz D klik

U¹ flexible mounting plate
uchwyt U sprężysty

U² cone U flexible mounting plate
uchwyt U sprężysty cone

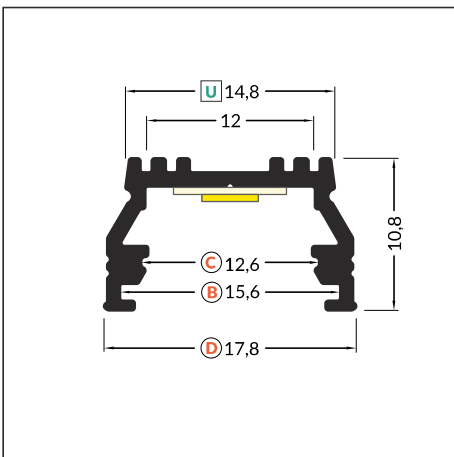
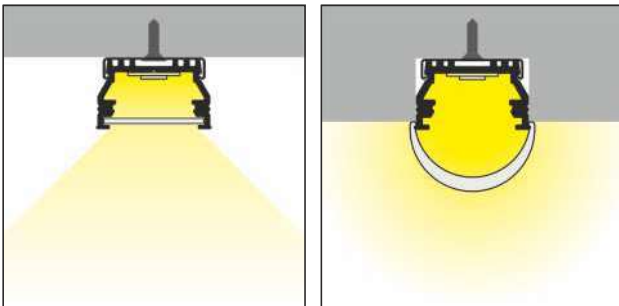
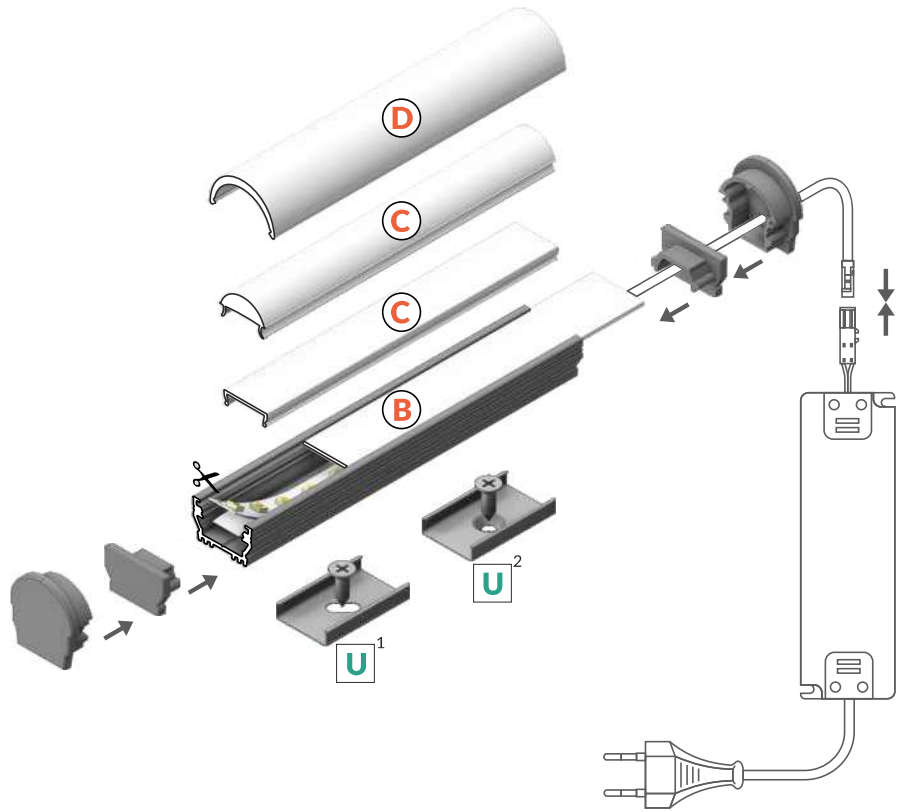

max 12 mm



surface
nawierzchniowy



recessed
wpustowy



INDEX = 1 pc, length 2000 mm
package > check the pricelist
INDEKS = 1 szt., długość 2000 mm
opakowanie > patrz cennik

white painted
biały malowany
A1020001



anodized
anodowany
A1020020



black anodized
czarny anodowany
A1020021



raw aluminium
surowe aluminium
A1020000

Available lengths: 1000 mm, 2000 mm, 3000 mm, 4000 mm.
The standard profile length tolerance is +20 mm.
More details >> 1.08.

Dostępne długości: 1000 mm, 2000 mm, 3000 mm, 4000 mm.
Standardowa tolerancja długości profili wynosi: +20 mm.
Więcej informacji >> 1.08.



COVERS / KLOSZE

B slide cover

colours: transparent, frosted, opal
material: PC, PP, PP

klosz B wsuwany
kolory: transparentny, szron, mleczny
materiał: PC, PP, PP



Note! Dimensions of the space to install LED source
Uwaga! Wymiary przestrzeni do zamontowania źródła LED

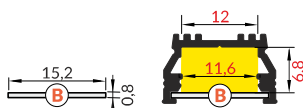

C click cover

colours: transparent, opal
material: PMMA

klosz C klik
kolory: transparentny, mleczny
materiał: PMMA

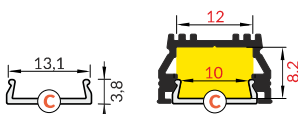

C lens click cover

colour: transparent
material: PC

klosz C klik soczewka
kolor: transparentny
materiał: PC

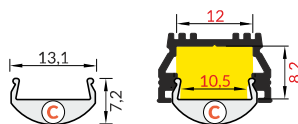

D click cover

colour: opal
material: PMMA

klosz D klik
kolor: mleczny
materiał: PMMA

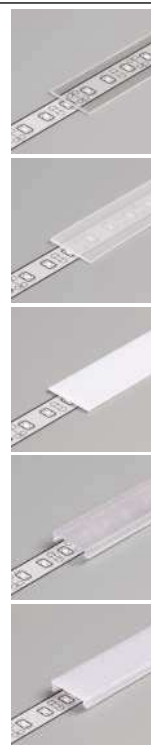
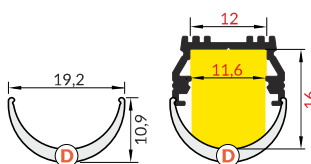

length 2000 mm
package > check the pricelist
długość 2000 mm
opakowanie > patrz cennik

B transparent / B transparentny
index = 10 pcs / indeks = 10 szt.
76250016

B frosted / B szron
index = 10 pcs / indeks = 10 szt.
76250039

B opal / B mleczny
index = 10 pcs / indeks = 10 szt.
76250038

C transparent / C transparentny
index = 1 pc / indeks = 1 szt.
76330000

C opal / C mleczny
index = 1 pc / indeks = 1 szt.
76330038

NEW



reel, length 20 m
package > check the pricelist
rolka, długość 20 m
opakowanie > patrz cennik

C opal / C mleczny
index = 1 pc / indeks = 1 szt.
76360038S



length 2000 mm
package > check the pricelist
długość 2000 mm
opakowanie > patrz cennik

C lens / C soczewka
index = 1 pc / indeks = 1 szt.
76300000

D opal / D mleczny
index = 1 pc / indeks = 1 szt.
A1140038

The standard cover length tolerance is +20 mm.
More details >> 1.08.

Standardowa tolerancja długości kloszy wynosi: +20 mm
Więcej informacji >> 1.08.

MOUNTINGS / MOCOWANIA

U flexible mounting plate

colour: inox
material: stainless steel

uchwyt U sprężysty
kolor: inox
materiał: stal nierdzewna

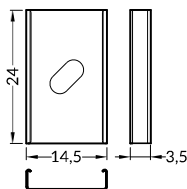
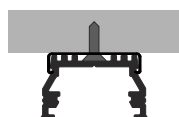

INDEX = 10 sets = 20 pcs
package > check the pricelist
INDEKS = 10 kpl = 20 szt.
opakowanie > patrz cennik

inox
76380000

cone U flexible mounting plate

colour: inox
material: stainless steel

uchwyt U sprężysty cone
kolor: inox
materiał: stal nierdzewna

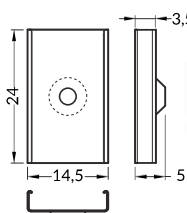
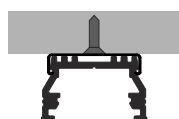

inox
76620000



CONNECTORS / ŁĄCZNIKI

UNI12 connector 90 deg
colours: white, anodized, black
material: aluminium

łącznik UNI12 90 st
kolory: biały, anodowany, czarny
materiał: aluminium

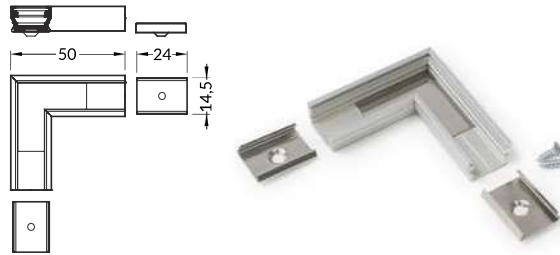

INDEX = 1 set, package > check the pricelist
INDEKS = 1 kpl., opakowanie > patrz cennik

white painted
biały malowany
A1910001
anodized
anodowany
A1910020
black anodized
czarny anodowany
A1910021

ENDINGS / ZAŚLEPKI

UNI12 ending gen2
colours: white, silver, black, grey
material: ABS

zaślepka UNI12 gen2
kolory: biały, srebrny, czarny, szary
materiał: ABS

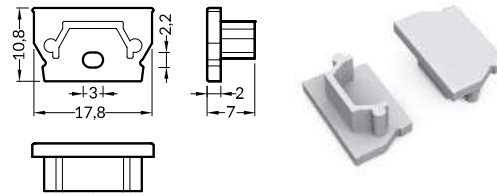

INDEX = 10 sets = 20 pcs
package > check the pricelist
INDEKS = 10 kpl = 20 szt.
opakowanie > patrz cennik

white / biały
A1900001
silver / srebrny
A1900040
black / czarny
A1900002
grey / szary
A1900022

UNI12 ending gen2 with hole
colours: white, silver, black, grey
material: ABS

zaślepka UNI12 gen2 z otworem
kolory: biały, srebrny, czarny, szary
materiał: ABS



white / biały
A1890001
silver / srebrny
A1890040
black / czarny
A1890002
grey / szary
A1890022

UNI12 D ending
colours: white, silver, black, grey
material: ABS

zaślepka UNI12 D
kolory: biały, srebrny, czarny, szary
materiał: ABS

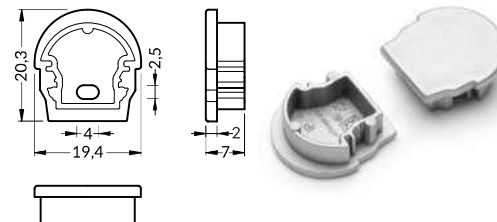

white / biały
A1940001
silver / srebrny
A1940040
black / czarny
A1940002
grey / szary
A1940022

UNI12 D ending with hole
colours: white, silver, black, grey
material: ABS

zaślepka UNI12 D z otworem
kolory: biały, srebrny, czarny, szary
materiał: ABS



white / biały
A1960001
silver / srebrny
A1960040
black / czarny
A1960002
grey / szary
A1960022

