

# SURFACE14 EF/TY

## ALUMINIUM SURFACE PROFILE

### ALUMINIOWY PROFIL NAWIERZCHNIOWY

- hidden mounting
- maximum LED strip width: 14 mm
- ukryte mocowanie
- maksymalna szerokość taśmy LED: 14 mm



## SIMILAR IN THE OFFER / PODOBNE W OFERCIE



SLIM8  
AC2/Z



SMART10  
AC2/Z



SURFACE10  
BC/UX



LINEA20  
EF/TY



WIDE24  
G/W



**E** slide cover  
klosz E wsuwany

**F** click cover  
klosz F klik

**E7** click cover  
klosz E7 klik

**Y**<sup>1</sup> Y flexible mounting plate  
uchwyt Y sprężysty

**Y**<sup>2</sup> cone Y flexible mounting plate  
uchwyt Y sprężysty cone

**T** mounting plate  
uchwyt T

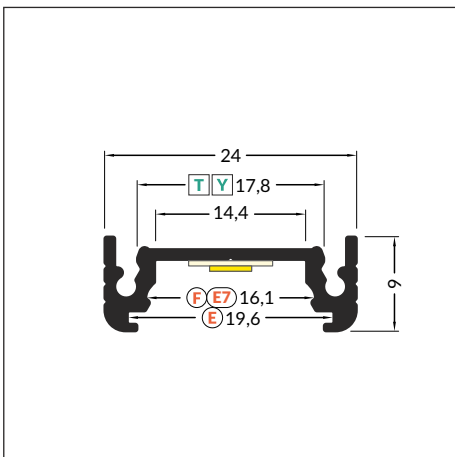
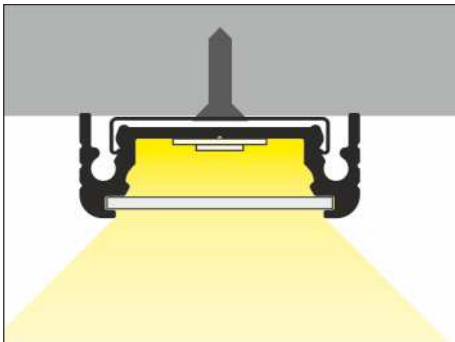
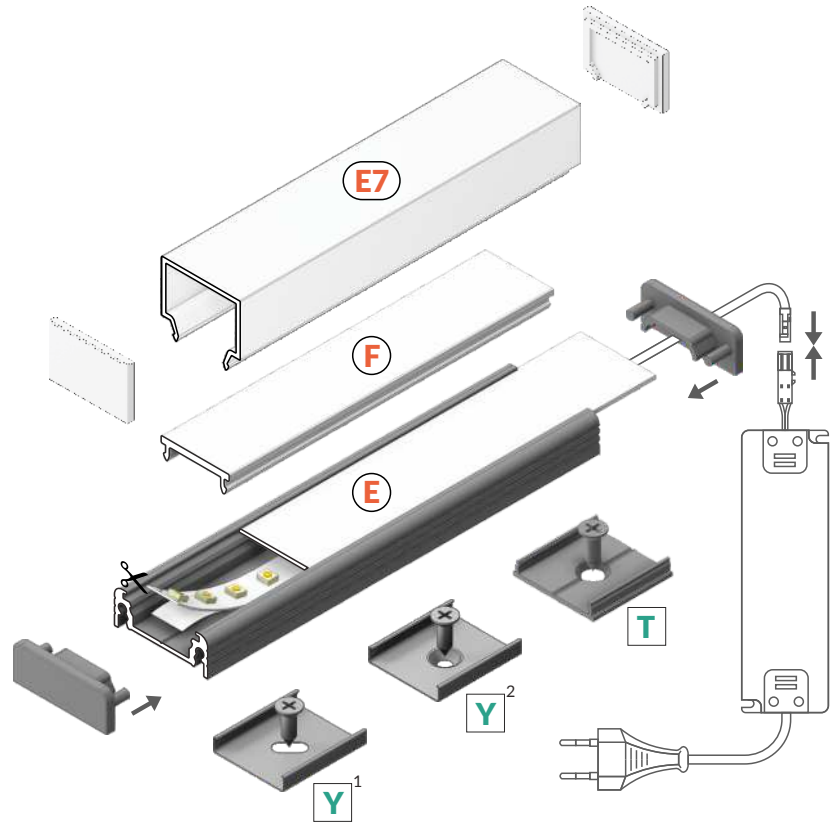

 max 14 mm

 surface  
nawierzchniowy



INDEX = 1 pc, length 2000 mm  
package > check the price list  
INDEKS = 1 szt., długość 2000 mm  
opakowanie > patrz cennik

white painted  
biały malowany  
A2020001



anodized  
anodowany  
A2020020



black anodized  
czarny anodowany  
A2020021



raw aluminium  
surowe aluminium  
A2020000

Available lengths: 1000 mm, 2000 mm, 3000 mm, 4000 mm.  
The standard profile length tolerance is +20 mm.  
More details >> 1.08.

Dostępne długości: 1000 mm, 2000 mm, 3000 mm, 4000 mm.  
Standardowa tolerancja długości profili wynosi: +20 mm.  
Więcej informacji >> 1.08.



## COVERS / KLOSZE

### E slide cover

colours: transparent, frosted, opal  
material: PC, PP, PP

klosz E wsuwany  
kolory: transparentny, szron, mleczny  
materiał: PC, PP, PP



**Note!** Dimensions of the space to install LED source  
**Uwaga!** Wymiary przestrzeni do zamontowania źródła LED

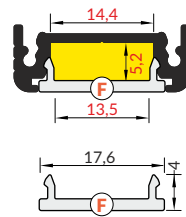
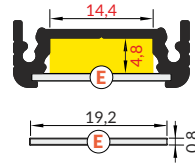

### F click cover

colours: transparent, opal  
material: PMMA

klosz F klik  
kolory: transparentny, mleczny  
materiał: PMMA

### E7 click cover

colour: opal  
material: PMMA

klosz E7 klik  
kolor: mleczny  
materiał: PMMA

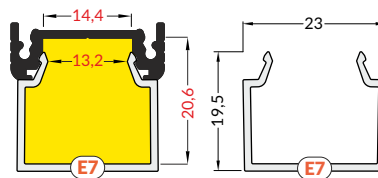

**NEW**

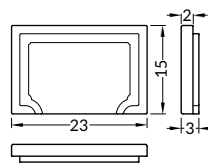

## MOUNTINGS / MOCOWANIA

### Y flexible mounting plate

colour: inox  
material: stainless steel

uchwyt Y sprężysty  
kolor: inox  
materiał: stal nierdzewna

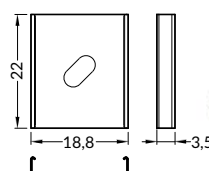
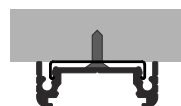

### cone Y flexible mounting plate

colour: inox  
material: stainless steel

uchwyt Y sprężysty cone  
kolor: inox  
materiał: stal nierdzewna

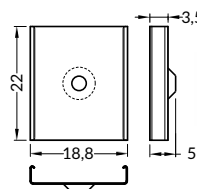
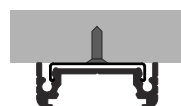

length 2000 mm  
package > check the pricelist  
długość 2000 mm  
opakowanie > patrz cennik

E transparent / E transparentny  
index = 10 pcs / indeks = 10 szt.

A2040016

E frosted / E szron  
index = 10 pcs / indeks = 10 szt.

A2040039

E opal / E mleczny  
index = 10 pcs / indeks = 10 szt.

A2040038

F transparent / F transparentny  
index = 1 pc / indeks = 1 szt.

A2060016

F opal / F mleczny  
index = 1 pc / indeks = 1 szt.

A2060038



reel, length 20 m  
package > check the pricelist  
rolka, długość 20 m  
opakowanie > patrz cennik

F opal / F mleczny  
index = 1 pc / indeks = 1 szt.

A2210038S



length 2000 mm  
package > check the pricelist  
długość 2000 mm  
opakowanie > patrz cennik

E7 opal / E7 mleczny  
index = 1 pc / indeks = 1 szt.

C1080038

The standard cover length tolerance is +20 mm.  
More details >> 1.08.

Standardowa tolerancja długości kloszy wynosi: +20 mm  
Więcej informacji >> 1.08.

INDEX = 1 set = 2 pcs  
package > check the pricelist  
INDEKS = 1 kpl = 2 szt.  
opakowanie > patrz cennik

E7 opal ending  
zaślepka E7 mleczny

C1840038

INDEX = 10 sets = 20 pcs  
package > check the pricelist  
INDEKS = 10 kpl = 20 szt.  
opakowanie > patrz cennik

inox  
A2090019

inox  
A2130019



## MOUNTINGS / MOCOWANIA

**T mounting plate**  
colour: raw aluminium  
material: aluminium

uchwyt **T**  
kolor: surowe aluminium  
materiał: aluminium

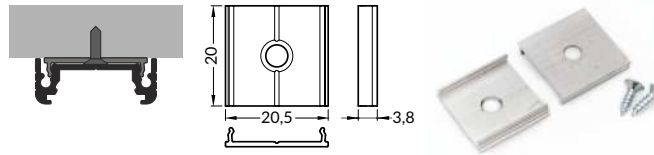

INDEX = 10 sets = 20 pcs  
package > check the pricelist  
INDEKS = 10 kpl = 20 szt.  
opakowanie > patrz cennik

raw aluminium  
surowe aluminium  
**C6960000**

## ENDINGS / ZAŚLEPKI

**SURFACE14 ending gen2**  
colours: white, silver, black, grey  
material: ABS

zaślepka SURFACE14 gen2  
kolory: biały, srebrny, czarny, szary  
materiał: ABS

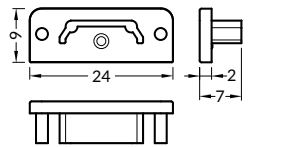

INDEX = 10 sets = 20 pcs  
package > check the pricelist  
INDEKS = 10 kpl = 20 szt.  
opakowanie > patrz cennik

white / biały  
**A2980001**  
silver / srebrny  
**A2980040**  
black / czarny  
**A2980002**  
grey / szary  
**A2980022**

**SURFACE14 ending gen2 with hole**  
colours: white, silver, black, grey  
material: ABS

zaślepka SURFACE14 gen2 z otworem  
kolory: biały, srebrny, czarny, szary  
materiał: ABS

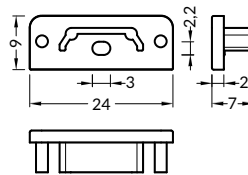

white / biały  
**A2970001**  
silver / srebrny  
**A2970040**  
black / czarny  
**A2970002**  
grey / szary  
**A2970022**

## CONNECTORS / ŁĄCZNIKI

**T connector 180 deg**  
colour: raw aluminium  
material: aluminium

łącznik **T** 180 st  
kolor: surowe aluminium  
materiał: aluminium

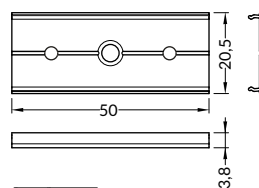

INDEX = 1 set, package > check the pricelist  
INDEKS = 1 kpl, opakowanie > patrz cennik

raw aluminium  
surowe aluminium  
**C6990000**

**SURFACE14 connector 90 deg**  
colours: white, anodized, black  
material: aluminium

łącznik SURFACE14 90 st  
kolory: biały, anodowany, czarny  
materiał: aluminium

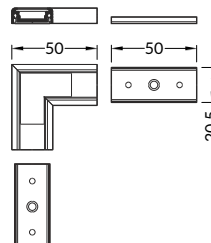

white painted / biały malowany  
**A2990001**

anodized / anodowany  
**A2990020**

black anodized  
czarny anodowany  
**A2990021**

