

GROOVE14 EF/TY

BASIC ALUMINIUM RECESSED PROFILE

PODSTAWOWY, ALUMINIOWY PROFIL WPUSTOWY

- used mainly in furniture
- maximum LED strip width: 14 mm
- głównie do zastosowania meblowego
- maksymalna szerokość taśmy LED: 14 mm



SIMILAR IN THE OFFER / PODOBNE W OFERCIE



DEEP10
BC/UX



GROOVE10
BC/UX



TRIO10
BC



UNI12
BCD/U



E slide cover
klosz E wsuwany

F click cover
klosz F klik

E7 click cover
klosz E7 klik

Y¹ flexible mounting plate
uchwyt Y sprężysty

Y² cone Y flexible mounting plate
uchwyt Y sprężysty cone

T mounting plate
uchwyt T

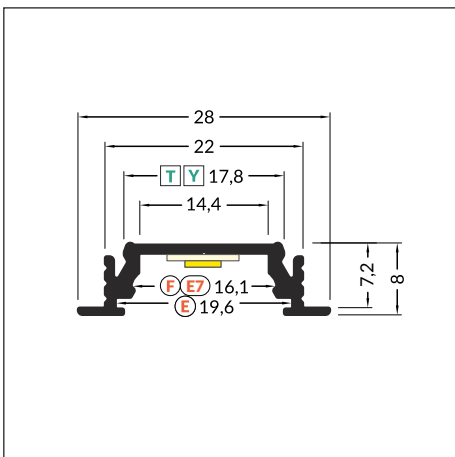
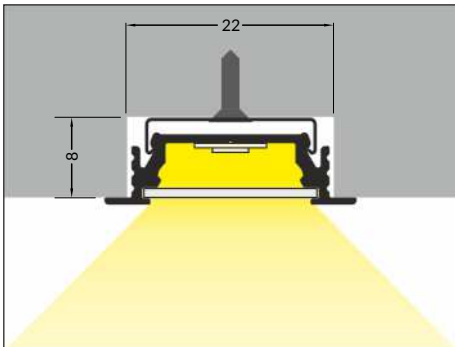
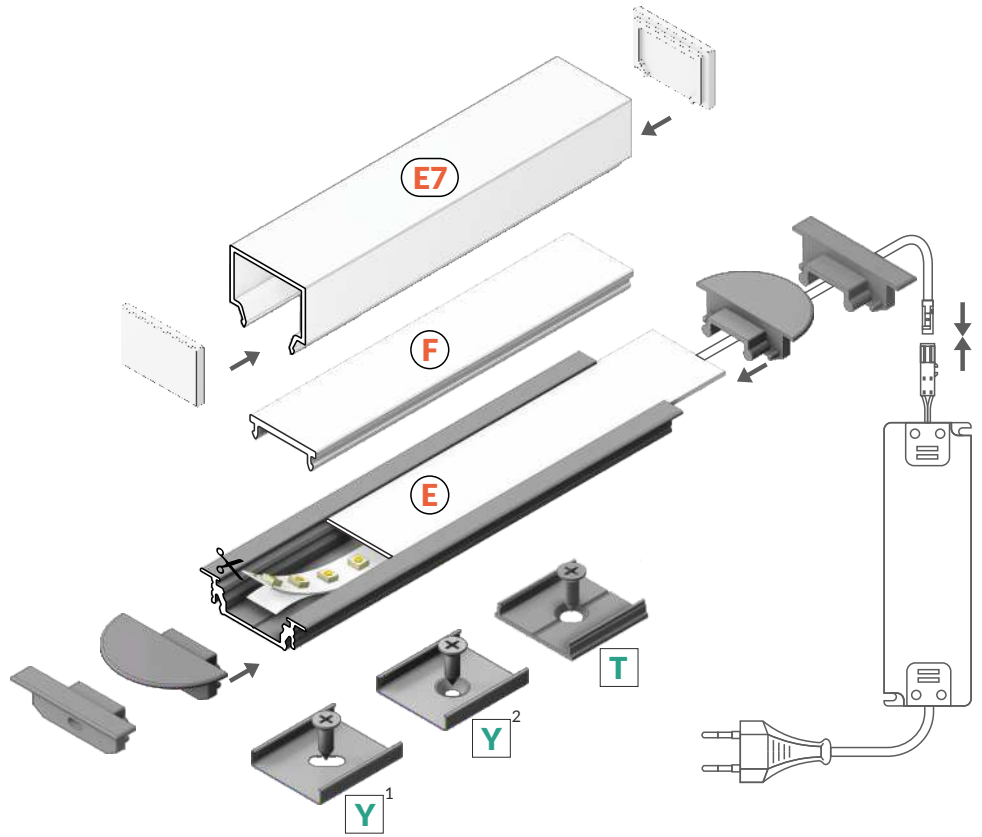

 max 14 mm

 recessed
wpustowy



INDEX = 1 pc, length 2000 mm
package > check the pricelist
INDEKS = 1 szt., długość 2000 mm
opakowanie > patrz cennik

white painted
biały malowany
A3020001



anodized
anodowany
A3020020



black anodized
czarny anodowany
A3020021



raw aluminium
surowe aluminium
A3020000

Available lengths: 1000 mm, 2000 mm, 3000 mm, 4000 mm.
The standard profile length tolerance is +20 mm.
More details >> 1.08.

Dostępne długości: 1000 mm, 2000 mm, 3000 mm, 4000 mm.
Standardowa tolerancja długości profili wynosi: +20 mm.
Więcej informacji >> 1.08.



COVERS / KLOSZE

E slide cover

colours: transparent, frosted, opal
material: PC, PP, PP

klosz E wsuwany
kolory: transparentny, szron, mleczny
materiał: PC, PP, PP



Note! Dimensions of the space to install LED source
Uwaga! Wymiary przestrzeni do zamontowania źródła LED

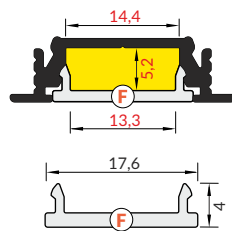
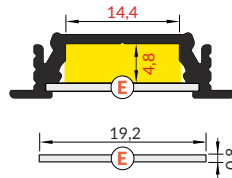

F click cover

colours: transparent, opal
material: PMMA

klosz F klik
kolory: transparentny, mleczny
materiał: PMMA

E7 click cover

colour: opal
material: PMMA

klosz E7 klik
kolor: mleczny
materiał: PMMA

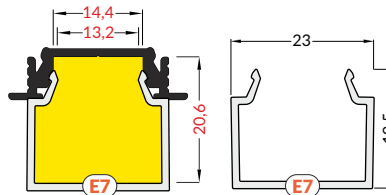

NEW

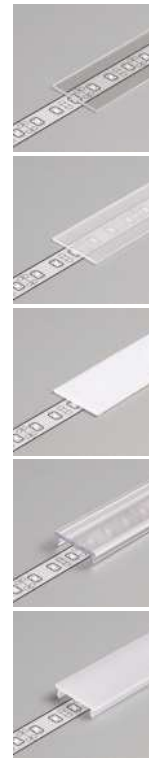

length 2000 mm
package > check the pricelist
długość 2000 mm
opakowanie > patrz cennik

E transparent / E transparentny
index = 10 pcs / indeks = 10 szt.

A2040016

E frosted / E szron
index = 10 pcs / indeks = 10 szt.

A2040039

E opal / E mleczny
index = 10 pcs / indeks = 10 szt.

A2040038

F transparent / F transparentny
index = 1 pc / indeks = 1 szt.

A2060016

F opal / F mleczny
index = 1 pc / indeks = 1 szt.

A2060038



reel, length 20 m
package > check the pricelist
rolka, długość 20 m
opakowanie > patrz cennik

F opal / F mleczny
index = 1 pc / indeks = 1 szt.

A2210038S



length 2000 mm
package > check the pricelist
długość 2000 mm
opakowanie > patrz cennik

E7 opal / E7 mleczny
index = 1 pc / indeks = 1 szt.

C1080038

The standard cover length tolerance is +20 mm.
More details >> 1.08.

Standardowa tolerancja długości kloszy wynosi: +20 mm
Więcej informacji >> 1.08.

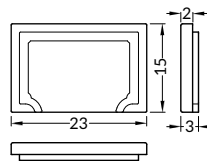

INDEX = 1 set = 2 pcs
package > check the pricelist
INDEKS = 1 kpl = 2 szt.
opakowanie > patrz cennik

E7 opal ending
zaślepka E7 mleczny

C1840038

MOUNTINGS / MOCOWANIA

Y flexible mounting plate

colour: inox
material: stainless steel

uchwyt Y sprężysty
kolor: inox
materiał: stal nierdzewna

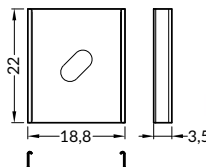
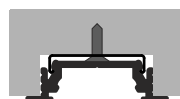

cone Y flexible mounting plate

colour: inox
material: stainless steel

uchwyt Y sprężysty cone
kolor: inox
materiał: stal nierdzewna

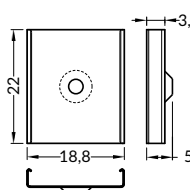
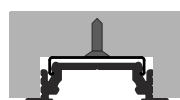

INDEX = 10 sets = 20 pcs
package > check the pricelist
INDEKS = 10 kpl = 20 szt.
opakowanie > patrz cennik

inox
A2090019

inox
A2130019



MOUNTINGS / MOCOWANIA

T mounting plate
colour: raw aluminium
material: aluminium

uchwyt **T**
kolor: surowe aluminium
materiał: aluminium

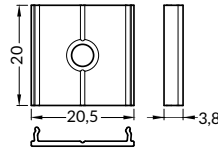
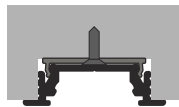

INDEX = 10 sets = 20 pcs
package > check the pricelist
INDEKS = 10 kpl = 20 szt.
opakowanie > patrz cennik

raw aluminium
surowe aluminium
C6960000

ENDINGS / ZAŚLEPKI

GROOVE14 ending gen2 with hole
colours: white, silver, black, grey
material: ABS

zaślepka GROOVE14 gen2 z otworem
kolory: biały, srebrny, czarny, szary
materiał: ABS

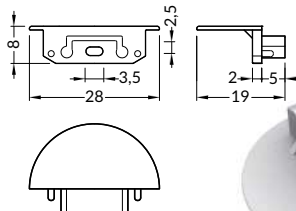

INDEX = 10 sets = 20 pcs
package > check the pricelist
INDEKS = 10 kpl = 20 szt.
opakowanie > patrz cennik

white / biały
A3970001
silver / srebrny
A3970040
black / czarny
A3970002
grey / szary
A3970022

GROOVE14 ending gen2 SQ with hole
colours: white, silver, black, grey
material: ABS

zaślepka GROOVE14 gen2 SQ z otworem
kolory: biały, srebrny, czarny, szary
materiał: ABS

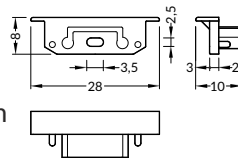

white / biały
A3980001
silver / srebrny
A3980040
black / czarny
A3980002
grey / szary
A3980022

CONNECTORS / ŁĄCZNIKI

T connector 180 deg
colour: raw aluminium
material: aluminium

łącznik **T** 180 st
kolor: surowe aluminium
materiał: aluminium

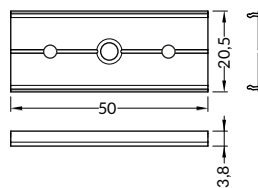

INDEX = 1 set, package > check the pricelist
INDEKS = 1 kpl, opakowanie > patrz cennik

raw aluminium
surowe aluminium
C6990000

GROOVE14 connector 90 deg
colours: white, anodized, black
material: aluminium

łącznik GROOVE14 90 st
kolory: biały, anodowany, czarny
materiał: aluminium

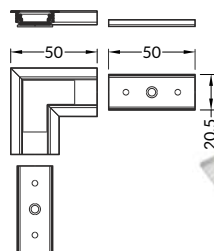

white painted
biały malowany
A3990001

anodized
anodowany
A3990020

black anodized
czarny anodowany
A3990021

