

Ultrathin RGB+CCT Touch Wheel RF Remote Controller

Model No.: R17/R8-5

1 and 4 zone RGB+CCT/Touch color wheel/Wireless remote 30m distance/CR2032 battery

Features

- Apply to RGB+CCT LED controller.
- Ultra sensitive color adjustment touch wheel.
- Each remote can match one or more receiver.
- CR2032 battery powered.
- Operate with LED indicator light.
- White & Black available.



CE RoHS EMC LVD RED

Technical Parameters

Input and Output		Safety and EMC		Environment	
Output signal	RF(2.4GHz)	EMC standard (EMC)	ETSI EN 301 489-1 V2.2.3 ETSI EN 301 489-17 V3.2.4	Operation temperature	Ta: -30°C ~ +55°C
Working voltage	3VDC(CR2032)	Safety standard(LVD)	EN 62368-1:2020+A11:2020	Package	
Working current	<5mA	Radio Equipment(RED)	ETSI EN 300 328 V2.2.2	Size	L114 x W65 x H20mm
Standby current	<10µA	Certification	CE,EMC,LVD,RED	Gross weight	0.062kg
Standby time	1 year			Warranty	
Remote distance	30m(Barrier-free space)			Warranty	5 years

Mechanical Structures and Installations

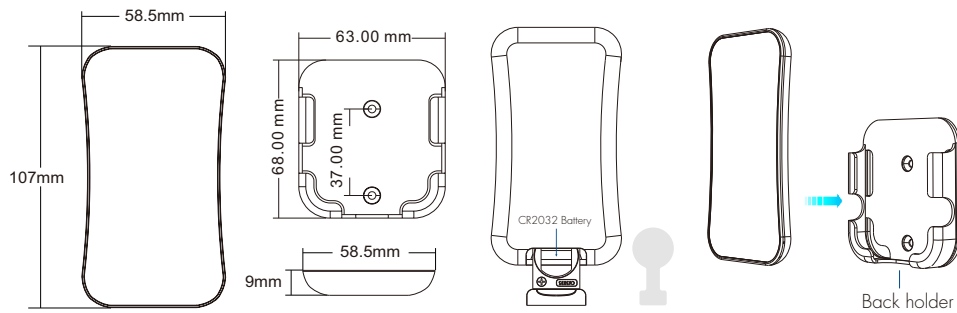

To fix the remote, two options are offered for selection:

- Option 1:
fix the remote' back holder on the wall with two screws.
- Option 2:
adhere the remote' back holder to the wall with pasteur.

- Note:** 1. Before the first use, please remove the protective film on the battery.
2. If the LED indicator is not on when press key, it is due to dead battery or bad contact caused by multiple plugging, please replace the battery, or raise the battery shrapnel with a screwdriver.

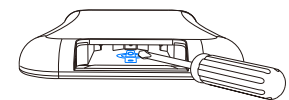

Operation

- When light is on, touch the color wheel, the indicator will display red.
- To extend battery life, no touch or press key operation after a few seconds, the touch wheel will enter sleep state, you need press any key to make touch wheel quit sleep state.

Match Remote Control (two match ways)

End user can choose the suitable match/delete ways. Two options are offered for selection:

Use the controller's Match key

Match:

Short press match key, immediately press on/off key (single zone remote) or zone key (multiple zone remote) of the remote.
The LED indicator fast flash a few times means match is successful.

Delete:

Press and hold match key for 5s to delete all match,
The LED indicator fast flash a few times means all matched remotes were deleted.

Use Power Restart

Match:

Switch off the power, then switch on power, repeat again.
Immediately short press on/off key (single zone remote) or zone key (multiple zone remote) 3 times on the remote.
The light blinks 3 times means match is successful.

Delete:

Switch off the power, then switch on power, repeat again.
Immediately short press on/off key (single zone remote) or zone key (multiple zone remote) 5 times on the remote.
The light blinks 5 times means all matched remotes were deleted.

Key function

● R17 1 zone RGB+CCT remote

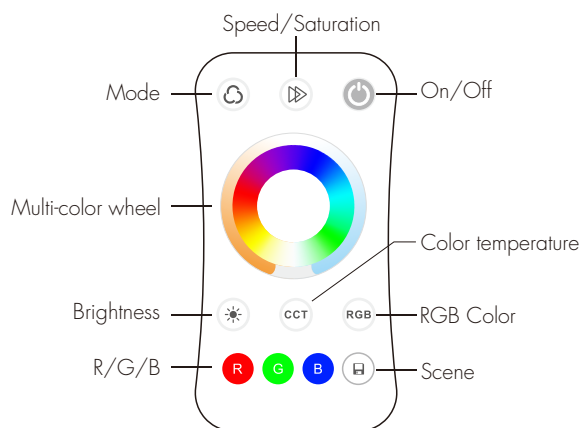

On/Off: Short press turn on/off light.

Mode: Switch dynamic mode, short press run the next mode, long press 2s run mode cycle.

Speed/Saturation:

For dynamic mode, adjust mode speed, short press 10 levels, long press 2s get the default speed. For static RGB color, adjust saturation, namely change current static color to mixed white slowly, short press 11 levels, long press 1-6s for continuous 256 levels adjustment.

Brightness: Adjust brightness, short press 11 levels, long press 2s get max or min brightness. at the same time, multi-color wheel become brightness wheel.

CCT: Adjust color temperature, short press 11 levels, long press adjust WW+CW brightness. at the same time, multi-color wheel become color temperature wheel.

Adjust color temperature by WW/CW channel.

RGB: Adjust static RGB color, short press get 24 kinds static color. at the same time, multi-color wheel become RGB color wheel.

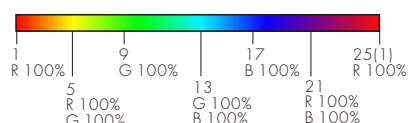

R/G/B: Short press get red, green or blue color directly.

long press 1-6s adjust R/G/B brightness continuously to achieve millions of colors.

Scene: Short press recall the scene, long press 2s save the current color into scene.

● R8-5 4 zone RGB+CCT remote

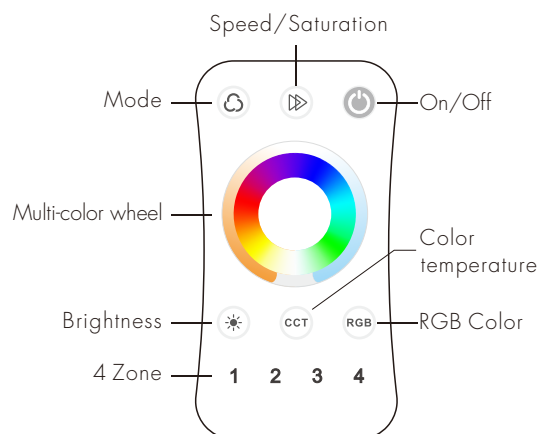

R8-5 can also be used as four zone universal remote, each zone can match single color, dual color(WW/CW), RGB, RGBW or RGB+WW/CW controller.

Zone 1/2/3/4 + * : Single color

Zone 1/2/3/4 + CCT : Dual color(WW/CW)

Zone 1/2/3/4 + RGB : RGB

Zone 1/2/3/4 + RGBW : RGBW

Zone 1/2/3/4 + RGB+WW/CW : RGB+WW/CW

For example, long press 1 and RGB key for 2s will set zone 1 as RGB light type.

When remote light type set ok, the red indicator will light on longer.

On/Off: Turn on/off all four zone light.

1,2,3,4 Zone: Short press turn on zone light, at the same time, select current zone.

Long press 2s turn off zone light.

Mode: Switch dynamic mode, short press run the next mode, long press 2s run mode cycle.

Speed/Saturation:

For dynamic mode, adjust mode speed, short press 10 levels, long press 2s get the default speed. For static RGB color, adjust saturation, namely change current static RGB color to mixed white slowly, short press 11 levels, long press 1-6s for continuous 256 levels adjustment.

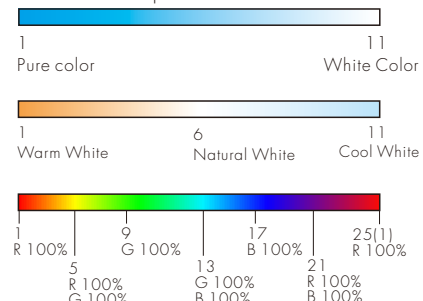

Brightness: Adjust brightness, short press 11 levels, long press 2s get max or min brightness. at the same time, multi-color wheel become brightness wheel.

CCT: Adjust color temperature, short press 11 levels, long press adjust WW+CW brightness. at the same time, multi-color wheel become color temperature wheel. Adjust color temperature by WW/CW channel.

RGB: Adjust static RGB color, short press get 24 kinds static color. at the same time, multi-color wheel become RGB color wheel.

Multi-color wheel

When it is brightness wheel, touch to change brightness.

When it is color temperature wheel, touch to change color temperature.

When it is RGB color wheel, touch to change RGB color.

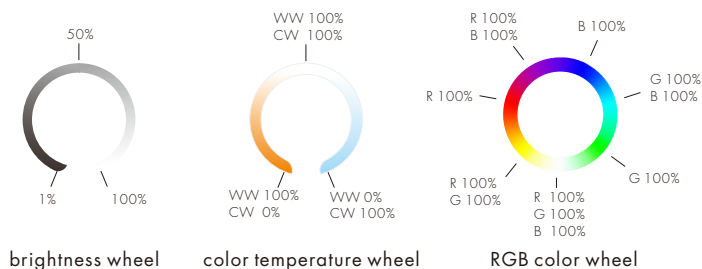

Safety information

1. Read all instructions carefully before you begin this installation.
2. When installing battery, pay attention to the battery positive and negative polarity. A long time without the remote control, remove the battery. When remote distance becomes smaller and insensitive, replace the battery.
3. If no response from the receiver, please re-match the remote.
4. Gently handle remote, beware of falling.
5. For indoor and dry location use only.