

# ES-DP

## Dual Push Button SPI LED Controller

# Stair Light Controller

- Dual push button input RGB or white light SPI LED controller.
- Two groups same SPI(TTL) signal output, drive 28 kinds IC digital RGB or white LED strip, IC type and R/G/B order can be set.

Compatible ICs:

TM1804, TM1809, TM1812, UCS1903, UCS1909, UCS1912, UCS2903, UCS2909, UCS2912, WS2811, WS2812, TM1829, TM1914A, GW6205, GS8206, GS8208, LPD6803, LPD1101, D705, UCS6909, UCS6912, LPD8803, LPD8806, WS2801, WS2803, P9813, SK9822, SM16703P.

- When applied to stair light, supports four output modes: color flow, white flow, color step, white step.
- Sequential switching control is realized when multiple SPI controllers are connected to a single self-resetting push switch button.
- Multiple light colors and change types are selectable with adjustable speed and brightness.
- Match with RF 2.4G remote control optional.

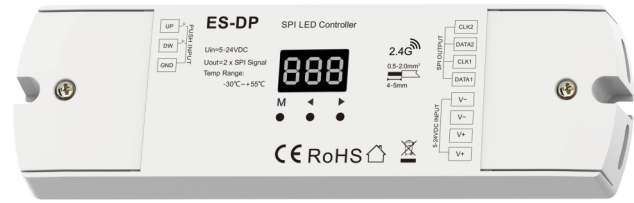

CE RoHS RED

### Technical Parameters

Input and Output		Environment		Safety and EMC	
Input voltage	5-24VDC	Operation temperature	Ta: -30°C ~ +55°C	EMC standard	EN 62479:2010 ETSI EN 301 489-1 V2.2.3 ETSI EN 301 489-17 V3.2.4
Input current	1.5A	Case temperature (Max.)	Tc: +65°C	Safety standard	EN 61347-1:2015+A1:2021 EN 61347-2-13:2014+A1:2017
Output signal	2 X SPI(TTL)	IP rating	IP20	Radio Equipment	ETSI EN 300 328 V2.2.2
Pixel number	Max 960	<b>Package</b>		Certification	CE EMC
Input signal	Push button + RF 2.4GHz	Size	L175 x W54 x H27mm	<b>Warranty</b>	
		Gross weight	0.126kg	Warranty	5 years

### Mechanical Structures and Installations

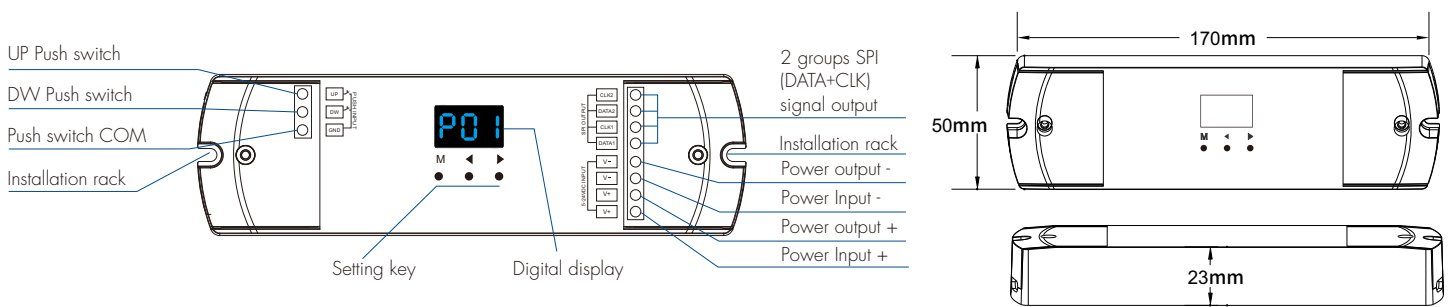

### Wiring Diagram

1. One controller connected to two self-resetting switches for up/down switch control

(1) Color / white light flow control stair light application

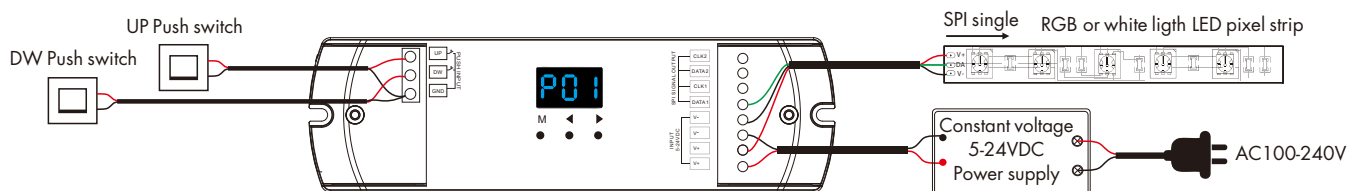

(2) Color / white light step control stair light application

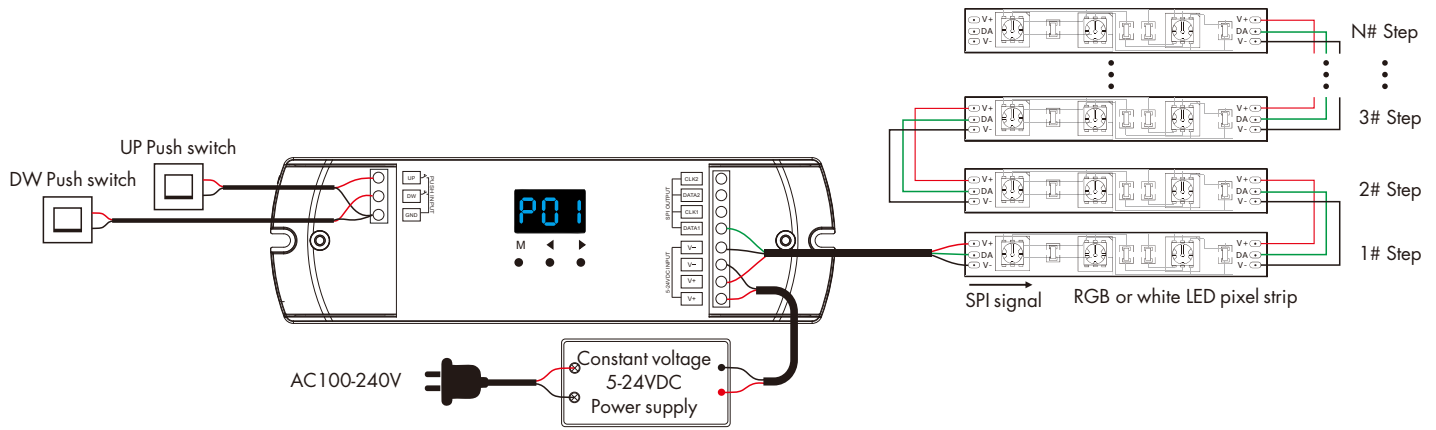

- Connect two push switches for manual control of stair lights. The UP push switch is installed at the bottom of the stairs; the DWV push switch is installed at the top of the stairs.
- Set the self-reset push switch to 0s for both light on delay and light off delay.
- Short press the self-reset push switch to turn on the light, display the current light effect mode; short press the self-reset push switch again, turn off the light, display "OFF".
- Long press the UP self-reset push switch to adjust the brightness, range 10-100%, digital tube display "b10"-bFF". (Note: The DW self-reset push switch does not have the function of adjusting the brightness.)

2. Multiple controllers connected to a self-resetting switch for sequential switch control

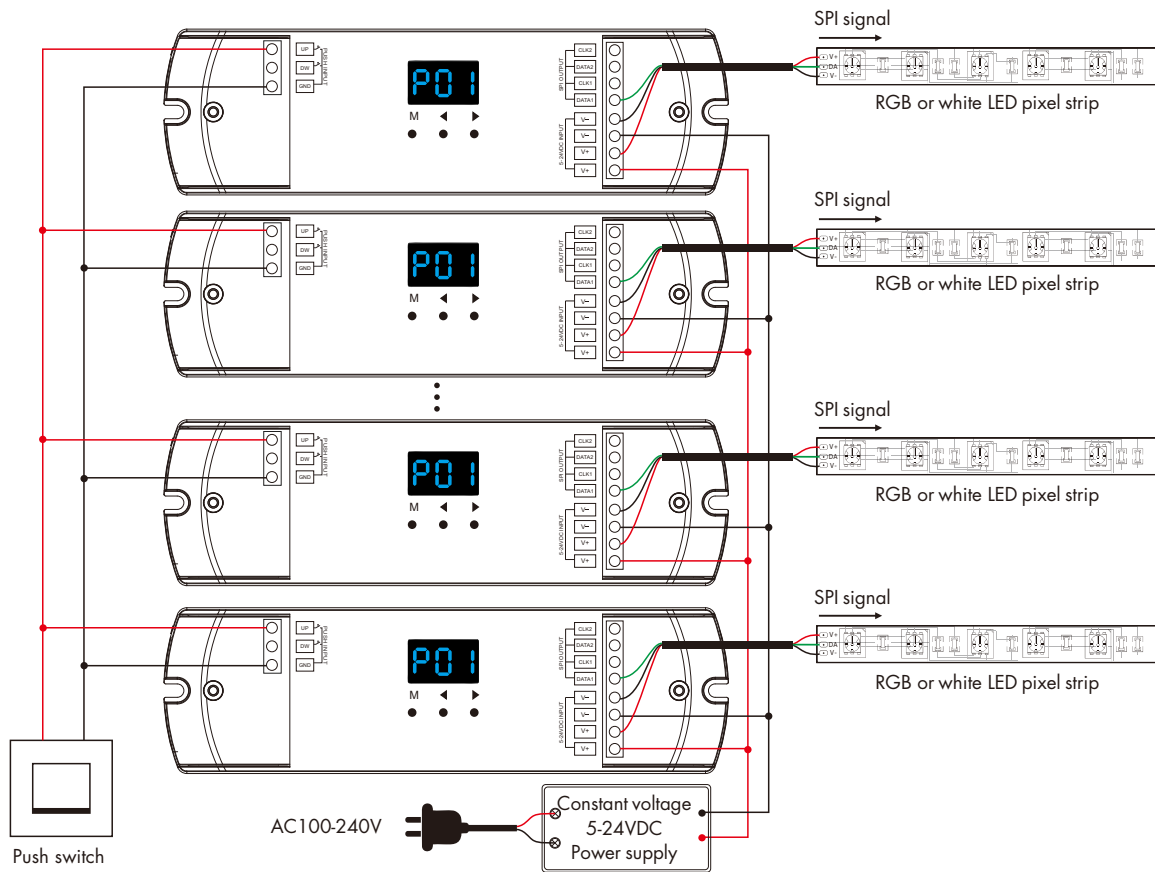

- Connect a self-reset push switch to the UP switch port (or DWV switch port, taking care not to mix them) of multiple controllers at the same time.
- Set the self-reset push switch light on/off delay time of multiple controllers to incremental or decremental values, for example: set 1-4# controllers' push switch light on delay time to 0s, 1s, 2s, 3s respectively, and push switch light off delay time to 3s, 2s, 1s, 0s respectively. In this way, 1-4# controllers will turn on the lights in the same order, and turn off the lights in the reverse order.
- Short press the self-reset push switch to turn on the lights sequentially. during the delayed light on time, digital display "don". When the light on, display the current light dynamic mode. Short press the self-reset push switch again to turn off the lights sequentially. during the delayed light off time, digital display "doF". When the lights off, digital display "OFF".
- When the lighting effects of multiple controllers are confused, it can be quickly restored by double-click the self-reset push switch.

**Installation Precautions:**

1. If the SPI LED strip is a single-wire control method, the DATA and CLK signal line outputs of the controller are same, and one controller can connect four LED strips.
2. If the SPI LED strip is a dual wire control method, one controller can connect two LED strips.
3. When the SPI strip load does not exceed 1.5A, the same power supply can simultaneously power the ES-DP controller and the SPI strip at the same time.  
When the load on the SPI strip exceeds 1.5A, separate power supplies are required for the ES-DP controller and the SPI strip.  
Only DATA and GND signal lines are connected between ES-DP controller and SPI strip.
4. The color or white light flow mode can control up to 960 pixel points of SPI strip.
5. The color or white light step mode defaults to 30 steps with 10 pixels per step. the step number x pixel length per step must  $\leq 960$ .

**Parameters Setting**

1. Long press the M and ◀ key for 2s simultaneously, enter the light parameters setting state: set the light type, LED strip connection mode (flow or step) pixel length, step number, light on/off mode, self-reset push switch turn on or off light delay time.

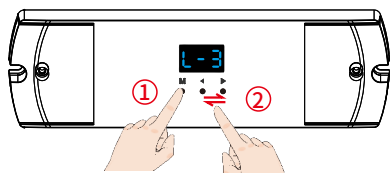
**(1) Light type setting**

**3-bead white light:** 1 pixel with 3 same data, control 3-bead white LED, display "L-1".

**1-bead white light:** 1 pixel with 1 data, control 1-bead white LED, display "L-2".

**RGB color light:** 1 pixel with 3 data, control one R/G/B LED, display "L-3".

- ① Short press M key enter light type setting interface;
- ② Short press ◀ or ▶ key to switch light type.

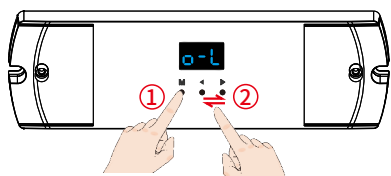
**(2) LED strip connection mode setting**

**Flow mode:** Straight line digital pixel LED strip connection mode, display "o-L".

**Step mode:** Z-shape digital pixel LED strip connection mode, display "o-S".

- ① Short press M key enter LED strip connection mode setting interface;
- ② Short press ◀ or ▶ key to switch LED strip connection mode.

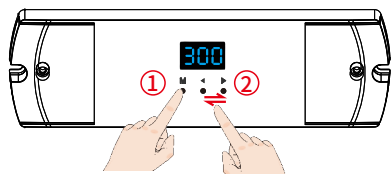
**(3) Pixel length setting**

**Pixel length:**

For color or white flow mode, set the number of pixel points, the range is 032-960, display "032"-960".

- ① Short press M key enter pixel length setting interface;
- ② Short press ◀ or ▶ key to set the pixel length.

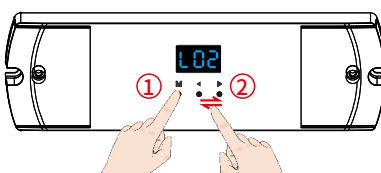
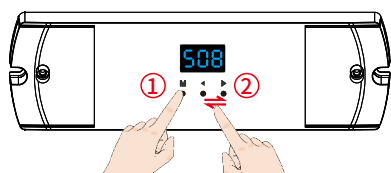
**(4) Step number and step pixel length setting**

- ① Short press M key enter step number setting interface;
- ② Short press ◀ or ▶ key to set the step number.

- ① Short press M key enter step pixel length setting interface;
- ② Short press ◀ or ▶ key to set the step pixel length.

**Step numbers and step pixel length:**

For color or white step mode, set the number of steps and pixel dot number of each step.

Step number: the range is 8-99, display "S08"-S99";

Pixel dot number of each step: the range is 2-99, display "L02"-L99".

the step number x pixel dot number of each step number must  $\leq 960$ .

## (5) Light on/off mode setting (Table 1)

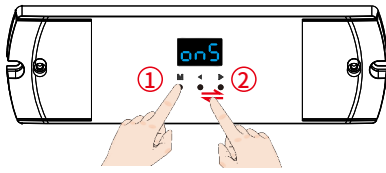

- ① Short press M key enter light on setting interface;  
 ② Short press ◀ or ▶ key to switch two light on mode:  
 Sequential light on:  
 Light turn on sequentially from the beginning to the end, display "onS" .  
 Synchronized light on:  
 Light turn on synchronously, display "onC" .

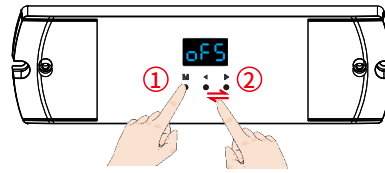

- ① Short press M key enter light off setting interface;  
 ② Short press ◀ or ▶ key to switch three light off mode:  
 Sequential light off:  
 Light turn off sequentially from the beginning to the end, display "oFS" .  
 Sequence light off in reverse:  
 Light turn off sequentially from end to beginning, display "oFb".  
 Synchronized light off:  
 Light turn off synchronously, display "oFC" .

## List of ways to turn on/off light combinations:

Display	Name
onS + oFS	Sequential light on, sequential light off
onS + oFb	Sequential light on, sequential reverse light off
onS + oFC	Sequential light on, synchronized light off
onC + oFS	Synchronized light on, sequential light off
onC + oFb	Synchronized light on, sequential reverse light off
onC + oFC	Synchronized light on, synchronized light off

(Table 1)

## (6) Self-reset push switch turn on or off light delay time setting

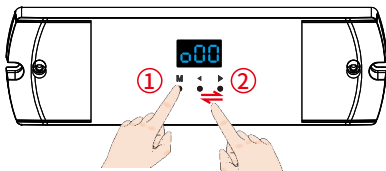

- ① Short press M key enter push switch turn on light delay time setting interface;  
 ② Short press ◀ or ▶ key to set the delay time.

## Self-reset push switch turn on light delay time:

Setting range 0-15.5s, the smallest unit 0.5s, display "o00"-o95"-oF5",  
 A-F indicates that 10-15s.  
 Setting 0s means turn on light immediately.

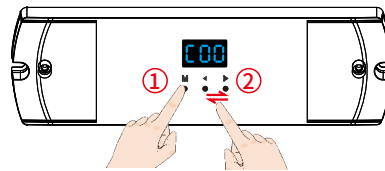

- ① Short press M key enter push switch turn off light delay time setting interface;  
 ② Short press ◀ or ▶ key to set the delay time.

## Selfreset push switch turn off light delay time:

Setting range 0-15.5s, the smallest unit 0.5s, display "c00"-c95"-cf5",  
 A-F indicates that 10-15s.  
 Setting 0s means turn off light immediately.

## 2. Long press the M and ▶key for 2s simultaneously, enter the LED strip parameters setting state: set the chip type, RGB color order.

## (1) Chip type setting

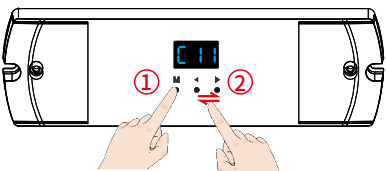

- ① Short press M key enter the chip type setting interface;  
 ② Short press ◀ or ▶ key to switch chip type (Table 2).

## (2) RGB color order setting

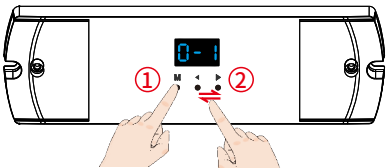

- ① Short press M key enter the RGB order setting setting interface;  
 ② Short press ◀ or ▶ key to switch R/G/B order (Table 3).

## 3. Quit the parameter setting

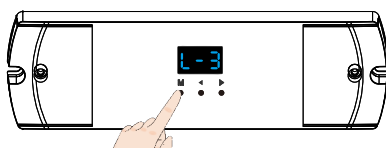

Long press the M key for 2s or wait for 15s, quit the parameter setting state.

## LED strip IC types list:

No.	IC type	Compatible IC type	Output signal
C11	TM1809	TM1804, TM1812, UCS1903, UCS1909, UCS1912, UCS2903, UCS2909, UCS2912, WS2811, WS2812, SM16703P	DATA
C12	TM1829		DATA
C13	TM1914A		DATA
C14	GW6205		DATA
C15	GS8206	GS8208	DATA
C21	LPD6803	LPD1101, D705, UCS6909, UCS6912	DATA, CLK
C22	LPD8803	LPD8806	DATA, CLK
C23	WS2801	WS2803	DATA, CLK
C24	P9813		DATA, CLK
C25	SK9822		DATA, CLK

(Table 2)

## LED strip RGB color order:

R/G/B order	RGB	RBG	GRB	GBR	BRG	BGR
Digital display	0-1	0-2	0-3	0-4	0-5	0-6

(Table 3)

(1) Light color setting

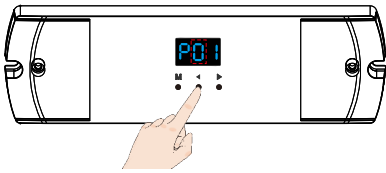

Short press ◀ key to switch 16 color light in sequence (Table 4).



Color Flow/Color Step mode, the digit shows P01~P95.



White Flow/White Step mode, the digit shows P-1~P-5.

(2) Light change type setting

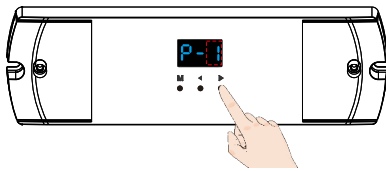

Short press ▶ key to switch 5 light change types in sequence (Table 5).

Color light type (2nd digit):

NO.	Name	NO.	Name
0	Rxxx Gxxx Bxxx (User define)	8	R/G/B 3 color
1	Red	9	7 color
2	Orange	A	Red + yellow
3	Yellow	b	Red + purple
4	Green	c	Green + yellow
5	Cyan	d	Green + cyan
6	Blue	E	Blue + cyan
7	Purple	F	Blue + purple

(Table 4)

(3) Light effect parameter setting (i.e., speed, brightness, Self-defined R/G/B color)

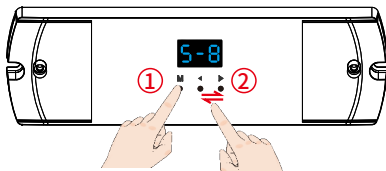

① Short press M key to switch three parameter items;

② Short press ◀ or ▶ key to adjust the value of each parameter item.

Speed, brightness, and self-defined R/G/B color parameter value description:

Speed: 1-8 levels adjustable, display "S-1"-"S-8", S-8 is the maximum speed.

Brightness: 1-10 level adjustable, display "b10"-"bFF", bFF means maximum brightness 100%.

Self-defined R/G/B color: 0-255 (00FF) adjustable.

R channel displays "100"-"1FF"; G channel displays "200"-"2FF"; B channel displays "300"-"3FF".

Color/white light change type (3rd digit):

NO.	Name
1	Flow
2	Chase
3	Float
4	Trail
5	Trail+black section

(Table 5)

(4) Quit light effect parameter setting

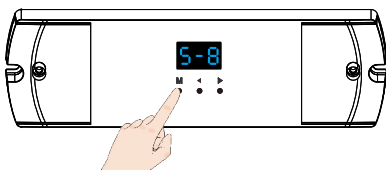

Long press the M key for 2s or wait for 15s, quit the light effect parameter setting state.

Note:

1. White flow / white step mode does not support self-defined R/G/B color function.
2. For color flow / color step mode, the light color and light change type are combined to form 50 kinds of light effects.
3. For color flow / color step / white flow / white step mode, can be adjusted in speed and brightness.

Match RF Remote Control

Long press M, ◀ and ▶ key for 2s simultaneously, the digital display "RLS", enter remote control matching status, immediately press on/off key (single zone remote) or zone key (multiple zone remote) of the remote, display "RLO" means successful match. When the light is turned off using the remote control, digital display "OFF".

Factory Default Parameter Setting

- Long press ◀ and ▶ key for 2s simultaneously, restore factory default parameters, display "RES".
- Factory default parameters: Clear all matched remote control, RGB color light flow output, 300 pixels, sequential light on, sequential light off, push switch turn on delay and turn off delay is 0s, chip type TM1809, RGB order.