

PROFIL LED HIDE10 C4 PLUS 1000 ANOD.







do szpachlowania



Architektoniczne

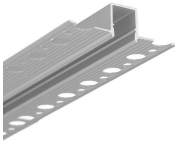

max 10 mm

	<ul style="list-style-type: none">• profil mieszczący się w grubości standardowej płyty kartonowo-gipsowej (12,5 mm)• ciągła linia światła przy użyciu taśmy 120 P/m	<ul style="list-style-type: none"> Wzory przemysłowe EU CE Wyprodukowane w Polsce	 <p>Kup produkt</p>
---	---	--	--

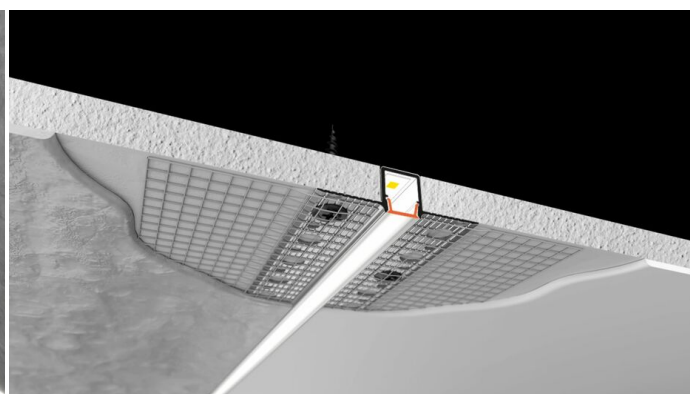
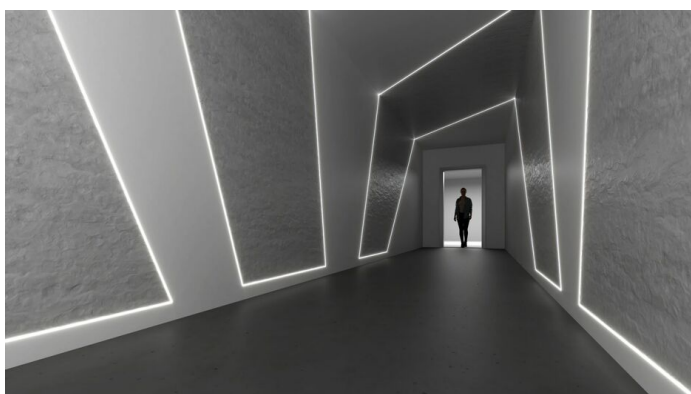
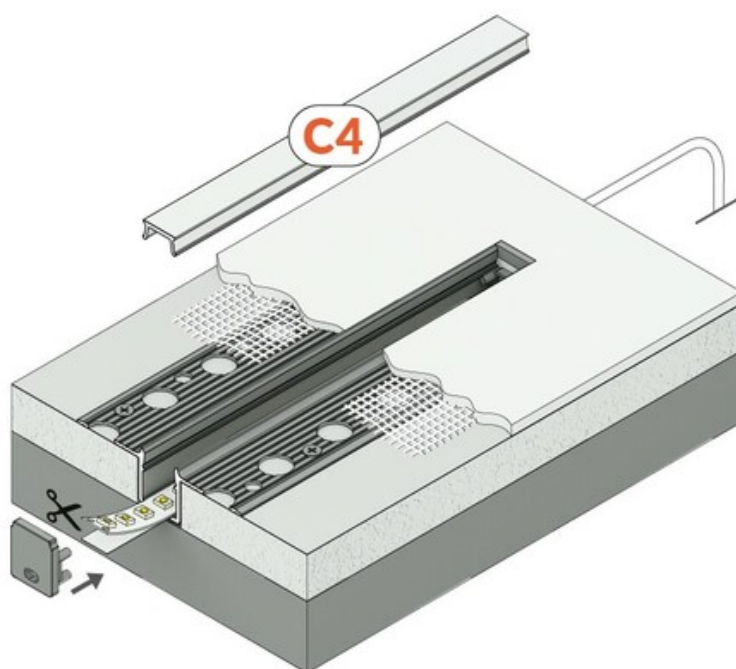

Informacje podstawowe

Indeks: H7000920 EAN: 5901597297888 Materiał: aluminium Kolor: anodowany Długość [mm]: 1000 Szerokość [mm]: 50.4 Wysokość [mm]: 14.7 Waga [kg]: 0.219 Producent: TOPMET Kraj pochodzenia, wytworzenia: PL	Jednostka miary: szt. Wymiary opakowania jednostkowego [mm]: 1000 x 50,4 x 14,7 Opakowanie zbiorcze [szt]: 40 Typ opakowania zbiorczego: pakiet Waga produktu z opakowaniem zbiorczym [kg]: 8.76
--	--

DOSTĘPNE KOLORY

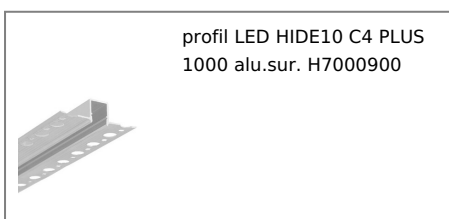

DOSTĘPNE WARIANTY

1000 mm, 2000 mm, 3000 mm, 4050 mm

Dopasowane elementy

KLOSZE DO PROFILI LED



ZAŚLEPKI DO PROFILI LED



**zaślepka HIDE10 z
otworem szary [20szt]**
index: H7999922