

# VARIO30

## RECESSED PROFILES PROFILE WPUSTOWE



scissors  
nożyczki



hacksaw  
piłka



glue  
klej



drill  
wiertarka



screwdriver  
wkrętek



metal shears  
nożyce do metalu



cotton gloves  
rękawiczki



spatula  
szpachelka

profiles profile	endings zaślepki	mountings mocowania			
04 LED profile VARIO30-04 profil LED VARIO30-04	04				
05 LED profile VARIO30-05 profil LED VARIO30-05	05				
06 LED profile VARIO30-06 profil LED VARIO30-06	06				
07 LED profile VARIO30-07 profil LED VARIO30-07	07	U9 mounting plate uchwyt U9	cone U9 mounting plate uchwyt U9 cone	rack U9 mounting plate uchwyt U9 rack	spring U9 mounting plate

### I VARIO30-04 VARIO30-05 diffuser / klosz A9, C9, D9, E9

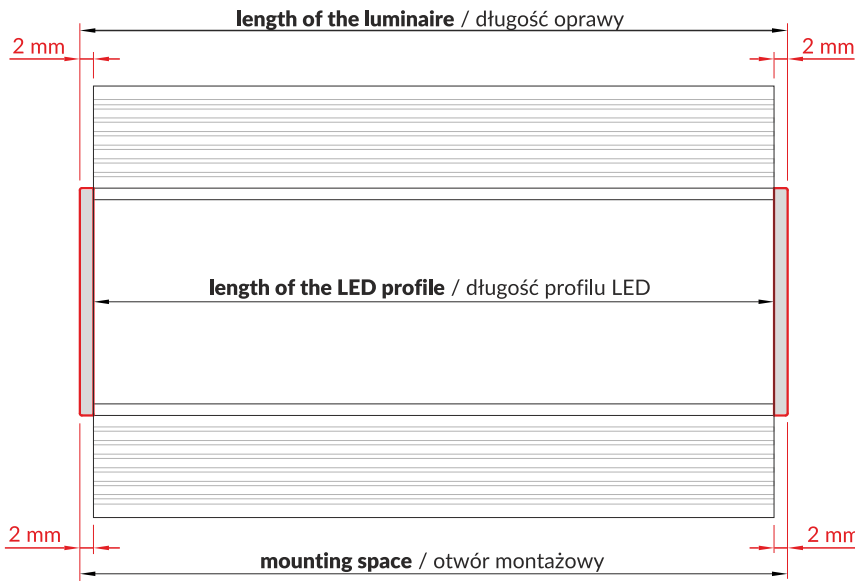

### VARIO30-06 VARIO30-07 diffuser / klosz A9, C9, D9, E9

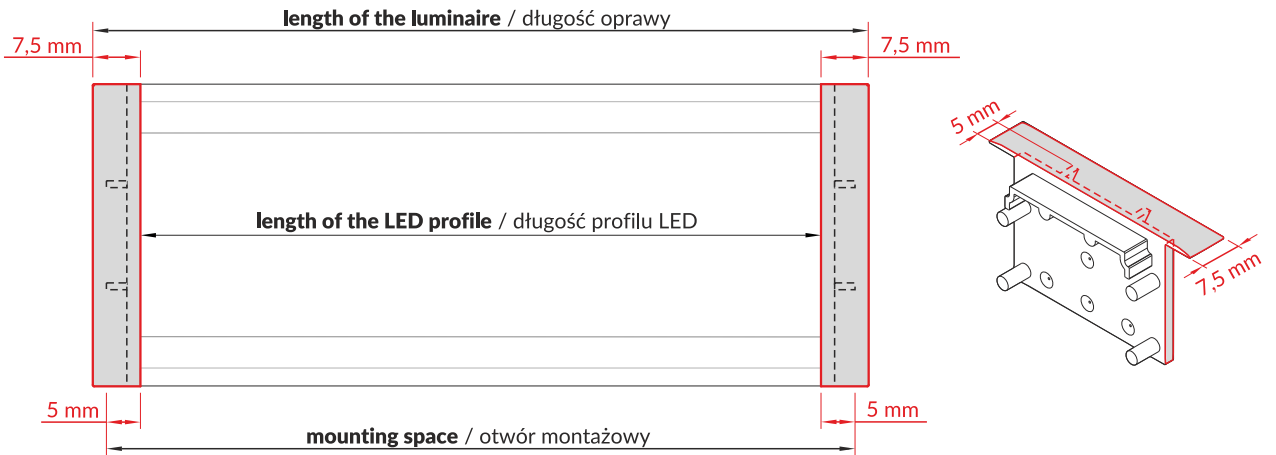

### II VARIO30-04 VARIO30-05 VARIO30-06 VARIO30-07 diffuser / klosz A9, C9, D9, E9

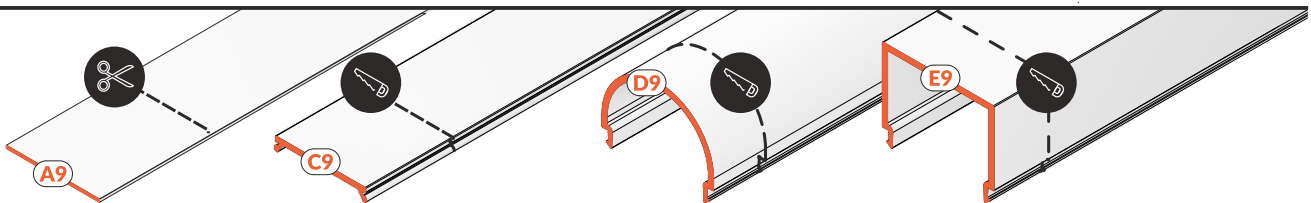

**Note!** The length of the cover is equal to the length of the profile.  
**Uwaga!** Długość klosza równa jest długości profilu.

**VARIO30-04**  
**VARIO30-05**  
**VARIO30-06**  
**VARIO30-07**  
**diffuser / klosz**  
**A9, C9, D9, E9**

**RECOMMENDED LED MODULE**  
**REKOMENDOWANY MODUŁ LED:**  
**PHILIPS Fortimo LED strip LV**

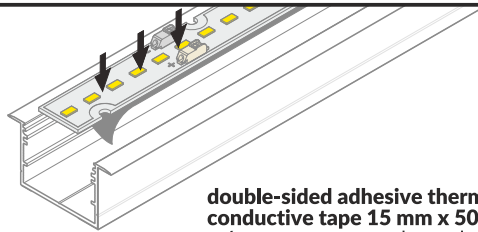

**double-sided adhesive thermally conductive tape 15 mm x 50 m**  
**taśma termoprzewodząca dwustronna 15 mm x 50 m**

**IV ACCESSORIES / AKCESORIA**

**VARIO30-04**  
**VARIO30-06**  
**diffuser / klosz**  
**A9, C9, D9, E9**

**VARIO30 LED clamp**  
**docisk LED VARIO30**

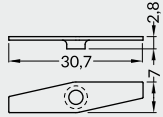

**x 6 / 1 m**

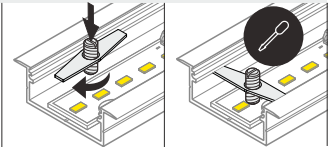
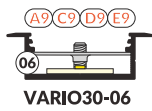

**VARIO30-05**  
**VARIO30-07**  
**diffuser / klosz**  
**A9, C9, D9, E9**

**VARIO30 LED mounting**  
**mocowanie LED VARIO30**

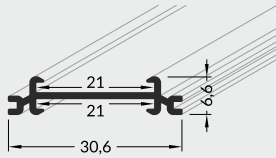

**VARIO30 LED clamp**  
**docisk LED VARIO30**

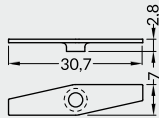

**x 6 / 1 m**

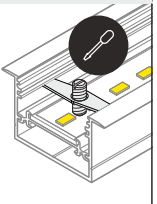
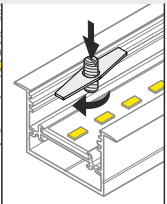
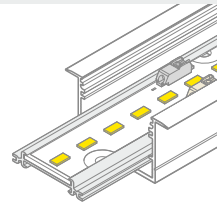
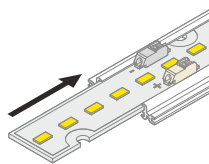
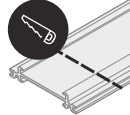
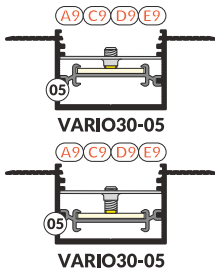

**VARIO30-05**  
**VARIO30-07**  
**diffuser / klosz**  
**A9, C9, D9, E9**

**VARIO30 LED 1 clamp**  
**docisk LED VARIO30 1**

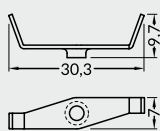

**x 6 / 1 m**

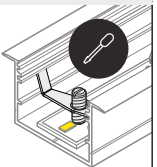
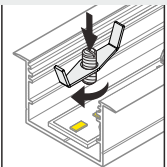
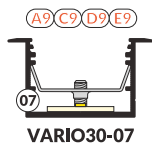
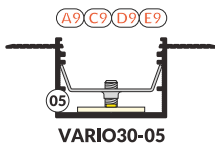

**VARIO30-05**  
**VARIO30-07**  
**diffuser / klosz**  
**A9, C9, D9, E9**

**VARIO30 reflector**  
**odbłyśnik VARIO30**

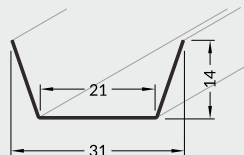

**VARIO30 LED 1 clamp**  
**docisk LED VARIO30 1**

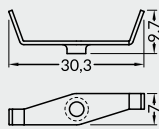

**x 6 / 1 m**

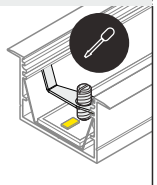
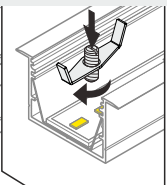
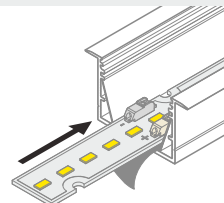
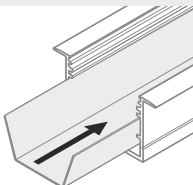
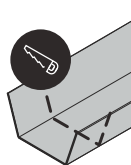
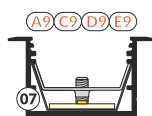
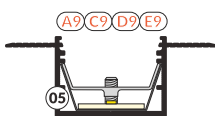

**double-sided adhesive thermally conductive tape 15 mm x 50 m**  
**taśma termoprzewodząca dwustronna 15 mm x 50 m**

**V**

**VARIO30-04**  
**VARIO30-05**  
**VARIO30-06**  
**VARIO30-07**  
 diffuser / klosz  
**A9, C9, D9, E9**

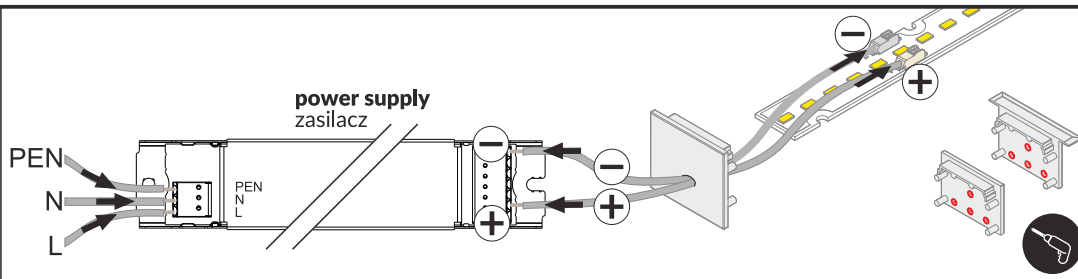

**Note!** Ending with marked space to bore the holes. Possibility of buying dedicated screws.  
**Uwaga!** Zaślepka z punktami do przewiercenia otworów. Istnieje możliwość zakupu dedykowanych wkrętów.

**VI**

**VARIO30-04**  
**VARIO30-05**  
 diffuser / klosz  
**A9**

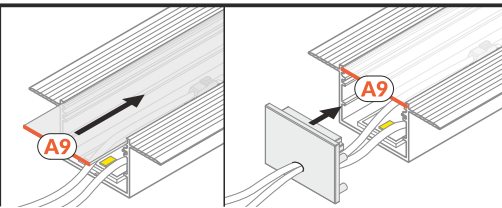

**VARIO30-06**  
**VARIO30-07**  
 diffuser / klosz  
**A9**

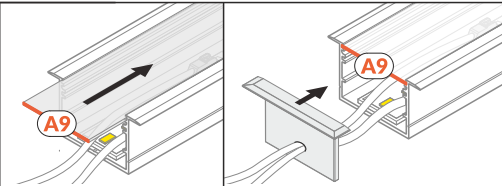

**VARIO30-04**  
**VARIO30-05**  
 diffuser / klosz  
**C9**

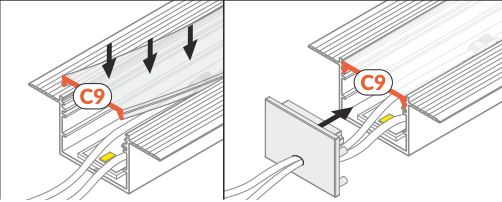

**VARIO30-06**  
**VARIO30-07**  
 diffuser / klosz  
**C9**

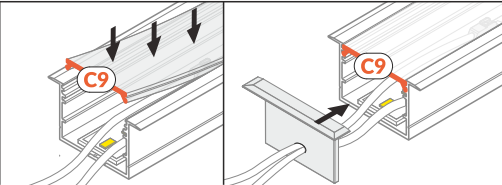

**VARIO30-04**  
**VARIO30-05**  
 diffuser / klosz  
**D9**

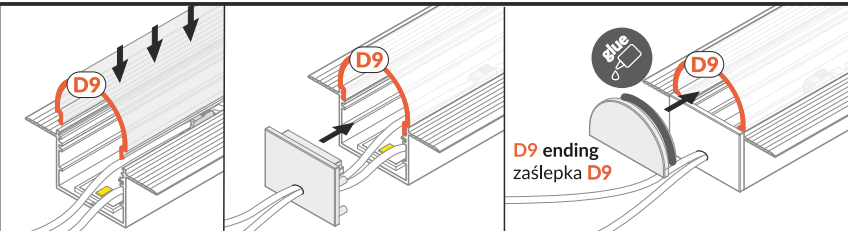

**VARIO30-06**  
**VARIO30-07**  
 diffuser / klosz  
**D9**

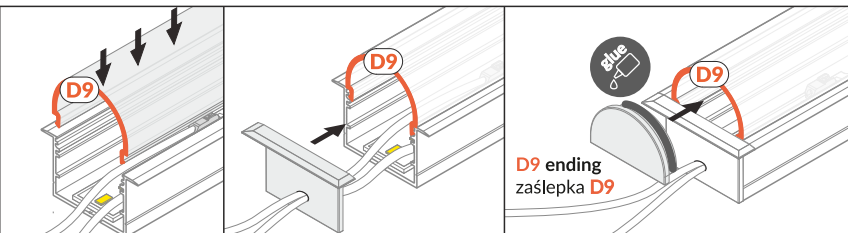

**VARIO30-04**  
**VARIO30-05**  
 diffuser / klosz  
**E9**

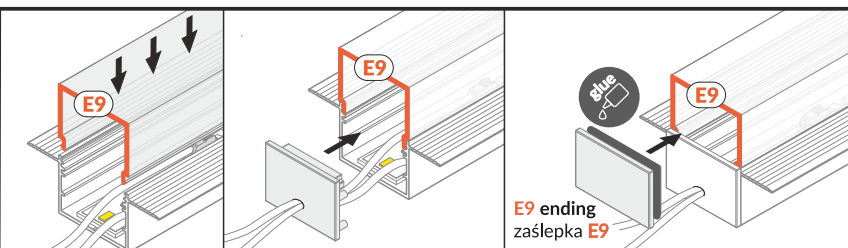

**VARIO30-06**  
**VARIO30-07**  
 diffuser / klosz  
**E9**

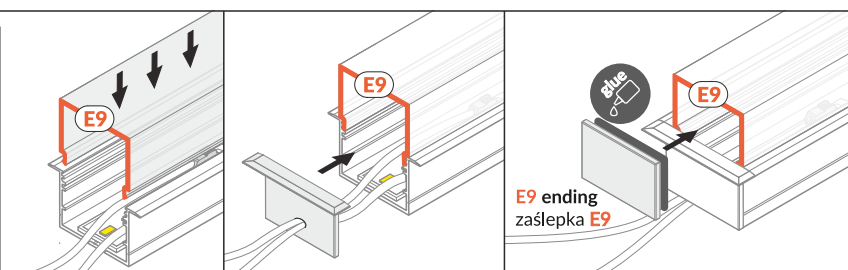

**VARIO30-04**  
diffuser / klosz  
A9, C9, D9, E9

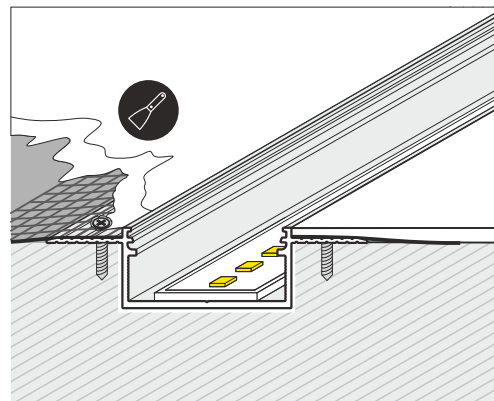
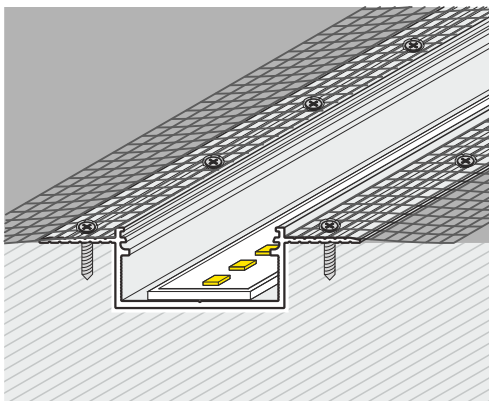
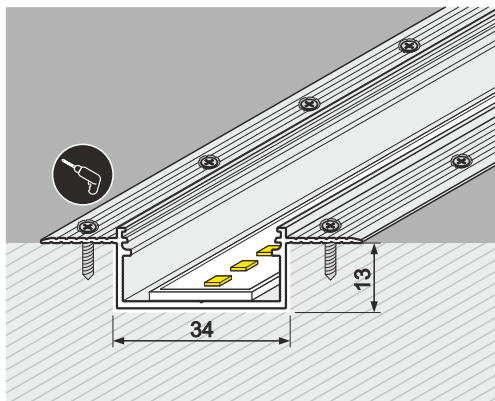

**VARIO30-05**  
diffuser / klosz  
A9, C9, D9, E9

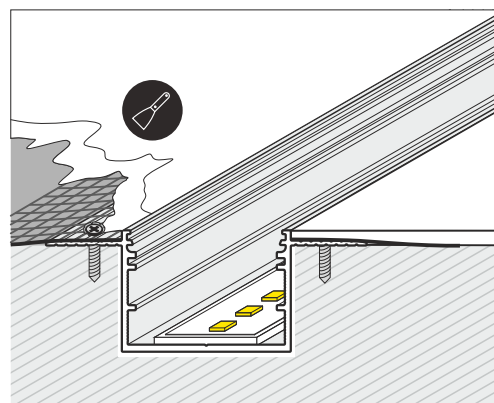
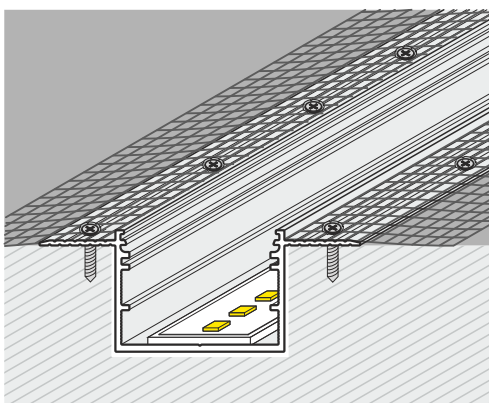
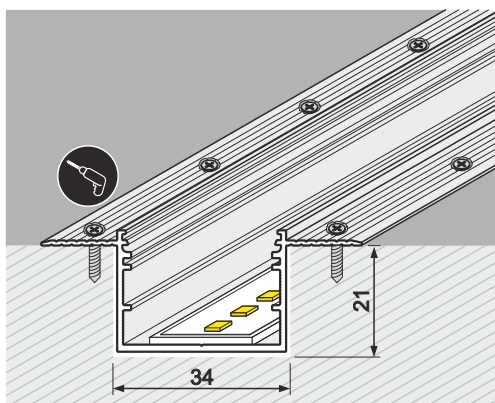

**VARIO30-06**  
**VARIO30-07**  
**diffuser / klosz**  
**A9, C9, D9, E9**

**U9**  
**mounting plate**  
 uchwyć U9

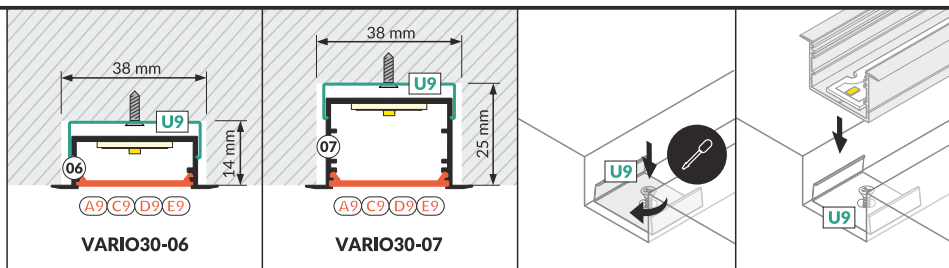

**cone U9**  
**mounting plate**  
 uchwyć U9 cone

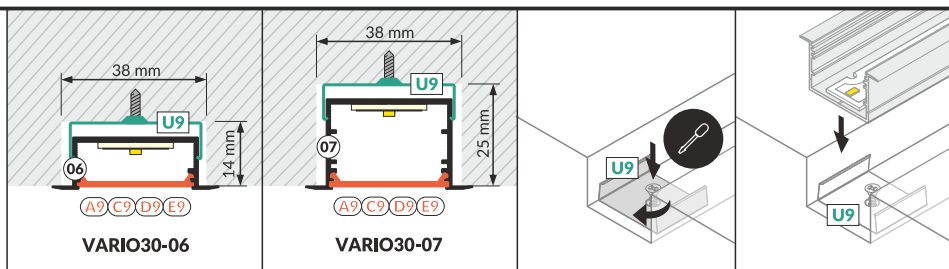

**rack U9**  
**mounting plate**  
 uchwyć U9 rack

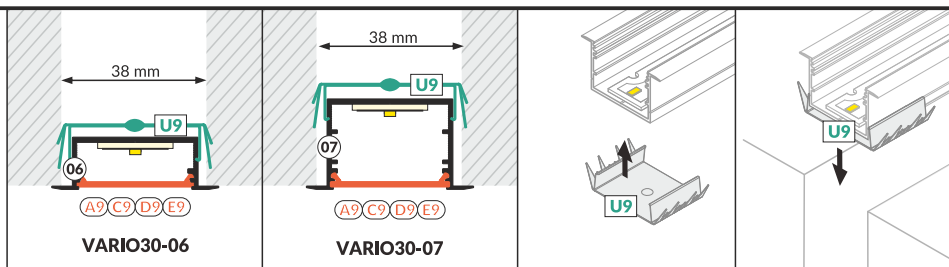

**spring U9** mounting plate  
 uchwyć U9 sprężyna

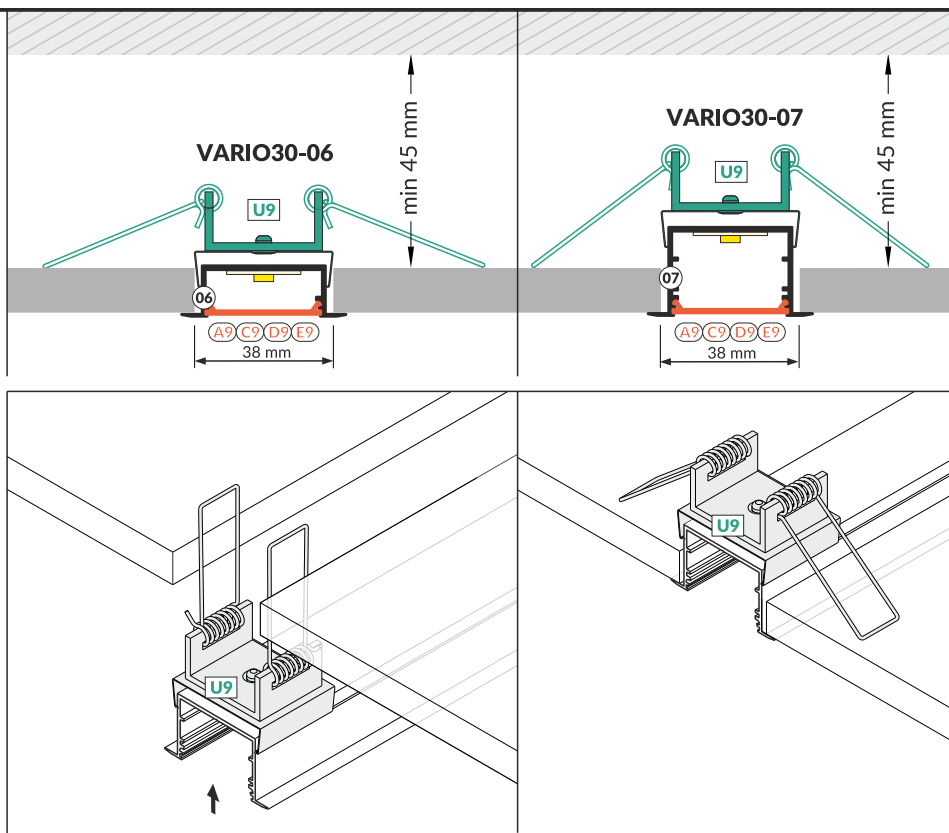

**glue**  
 klej montażowy

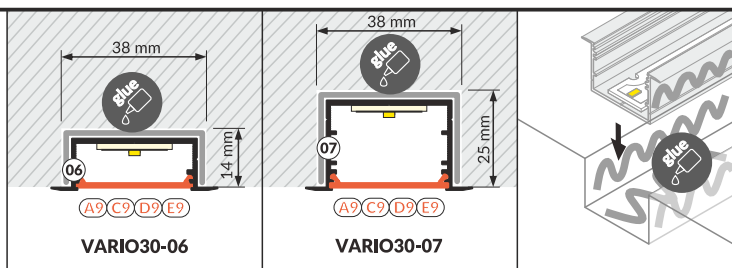

**VARIO30-05**  
**VARIO30-07**  
**diffuser / klosz**  
**A9, C9, D9, E9**

Available angular connectors:  
 Dostępne łączniki kątowe:

**VARIO30-05**

1. **VARIO30-05 connector 60 deg** / łącznik VARIO30-05 60 st
2. **VARIO30-05 connector 90 deg** / łącznik VARIO30-05 90 st
3. **VARIO30-05 connector 90 deg bent** / łącznik VARIO30-05 90 st gięty
4. **VARIO30-05 connector 120 deg** / łącznik VARIO30-05 120 st
5. **VARIO30-05 connector 135 deg** / łącznik VARIO30-05 135 st
6. **VARIO30-05 connector 180 deg** / łącznik VARIO30-05 180 st
7. **VARIO30-05 connector 270 deg bent** / łącznik VARIO30-05 270 st gięty

**VARIO30-07**

1. **VARIO30-07 60 connector deg** / łącznik VARIO30-07 60 st
2. **VARIO30-07 90 connector deg** / łącznik VARIO30-07 90 st
3. **VARIO30-07 90 connector deg bent** / łącznik VARIO30-07 90 st gięty
4. **VARIO30-07 120 connector deg** / łącznik VARIO30-07 120 st
5. **VARIO30-07 135 connector deg** / łącznik VARIO30-07 135 st
6. **VARIO30-07 180 connector deg** / łącznik VARIO30-07 180 st
7. **VARIO30-07 270 connector deg bent** / łącznik VARIO30-07 270 st gięty

**CONNECTION POSSIBILITIES**  
**MOŻLIWOŚCI ŁĄCZENIA**



60°



90°



90° bent / gięty



120°



135°



180°



270° bent / gięty

**VARIO30-05**  
**VARIO30-07**  
**diffuser / klosz**  
**A9, C9, D9, E9**

**VARIO30-07 180 deg**  
 łącznik VARIO30-07 180 st

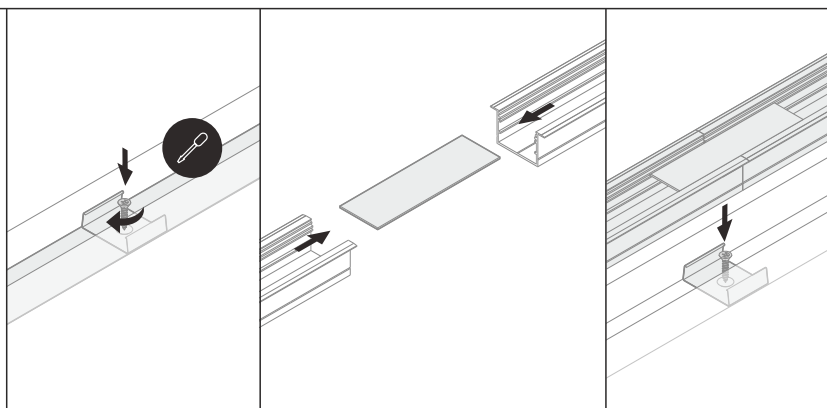

**VARIO30-05**  
**VARIO30-07**  
**diffuser / klosz**  
**A9, C9, D9, E9**

**VARIO30-07 90 deg**  
 łącznik VARIO30-07 90 st

Every connector  
 is installed similarly  
 to LINEA20 connector  
 90 deg.  
 Każdy łącznik montowany  
 jest analogicznie  
 do łącznika  
 LINEA-IN20 90 st.

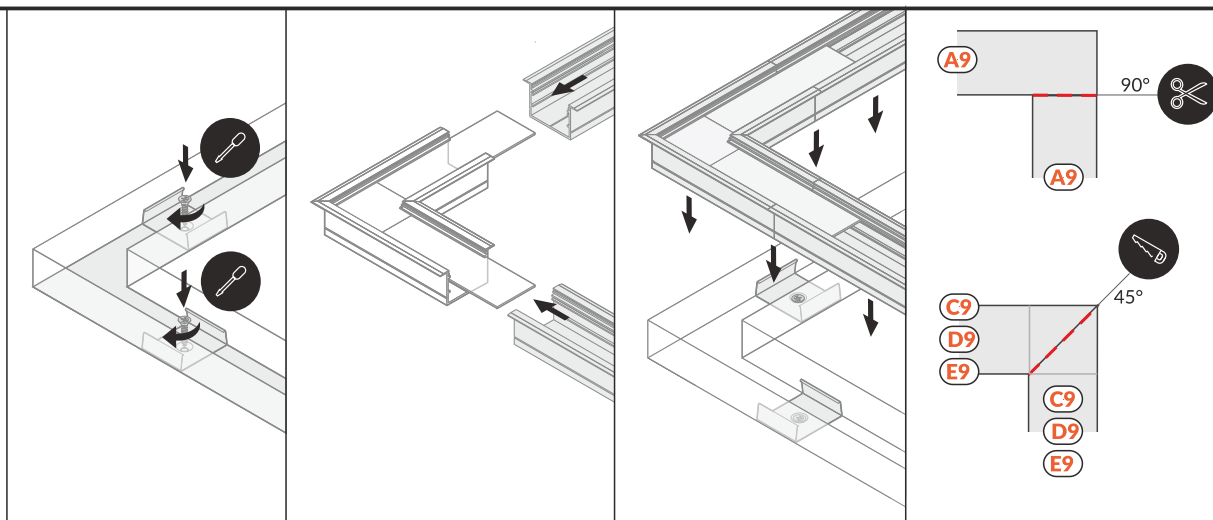

**X POWER SUPPLY / ZASILANIE**

**VARIO30-04**  
**VARIO30-05**  
**VARIO30-06**  
**VARIO30-07**  
**diffuser / klosz**  
**A9, C9, D9, E9**

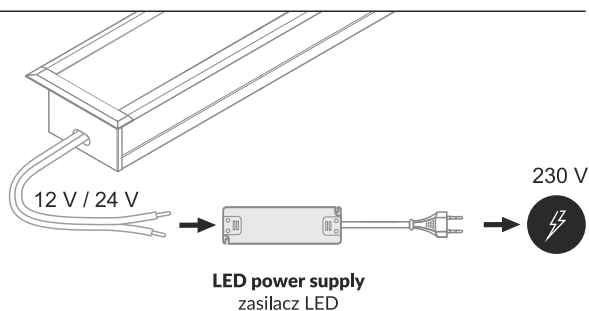

**ACCESSORIES / AKCESORIA**

**power switches** / włączniki  
**controller + remote** / sterownik + pilot  
**movement sensors** / czujniki ruchu

**Check the rest - TOPMET catalogue on [www.topmet.pl/en](http://www.topmet.pl/en)**  
 Zobacz więcej - katalog TOPMET lub [www.topmet.pl](http://www.topmet.pl)

[www.topmet.pl](http://www.topmet.pl)

