

S1-K



Rotary Glass Panel AC Triac Dimmer

- Rotary glass panel AC phase-cut dimmer, 1 channel output.
- To dim and switch single color dimmable LED lamps, traditional incandescent and halogen lights.
- Rotate knob to change brightness, support push and long push operation.
- 256 levels 0-100% dimming smoothly without any flash.
- Leading edge dimming or trailing edge dimming set by dip switch.
- Light on/off fade time 3s selectable.
- Compatibility with RF 2.4G single zone or multiple zone dimming remote control.
- Over-heat / Over-load protection, recover automatically.
- White & Black glass panel available.



Technical Parameters

Input and Output		Dimming data		Safety and EMC	
Input voltage	AC100-240V	Input signal	Rotary knob + RF 2.4GHz	EMC standard	EN IEC 55015/EN IEC 61547 ETSI EN 301 489-1/-3
Output voltage	AC100-240V	RF Control distance	10m(Barrier-free space)	Safety standard	EN 61347-1/-2
Output current	Max 1.5A	Dimming level	256 levels	Radio Equipment	ETSI EN 300 440
Output power	150-360W	Dimming range	0-100%	Certification	CE RoHS FCC
Environment		Package		Warranty	
Operation temperature	Ta: -30 °C ~ +55 °C	Size	L112 x W112 x H60mm	Warranty	5 years
Case temperature (Max.)	Tc: +85 °C	Gross weight	0.234kg		
IP rating	IP20				

Mechanical Structures and Installations

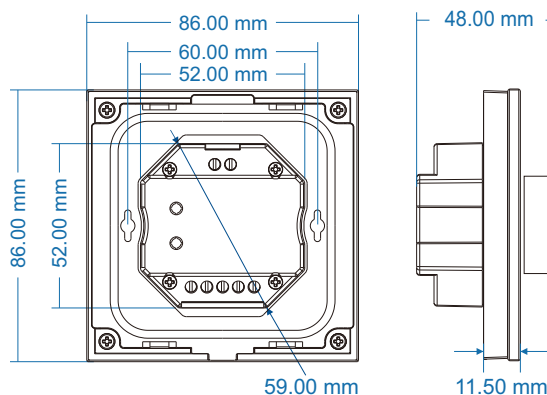
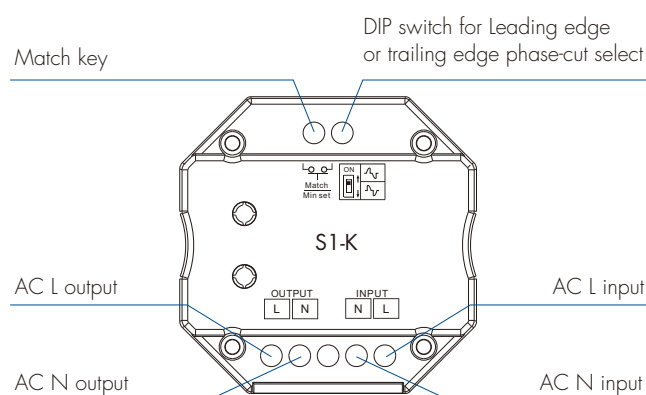

Installation diagram:

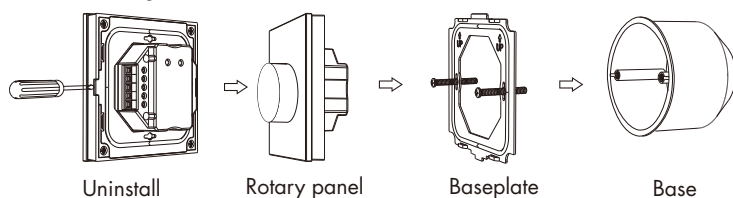

Typical base as below:

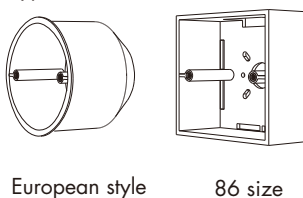

Compatible Load Types

Load Type	Maximum Load	Remarks
Dimmable LED lamps	200W @ 220V 100W @ 110V	Due to variety of LED lamp designs, maximum number of LED lamps is further dependent on power factor result when connected to dimmer.
Triac Dimmable LED drivers	200W @ 220V 100W @ 110V	Maximum permitted number of drivers is 200W divided by driver rated input power, and make sure the surge current is no more than 2 times 65A.
Incandescent lighting, HV Halogen lamps	400W @ 220V 200W @ 110V	

Knob Function

- Push: Turn on or off light.
After turn on light:
- Rotate: Rotate knob to adjust brightness, 2.5 turns, 50 levels.
- Long push(1-6s): Continuous 256 levels brightness adjustment.

⚠ Caution: Please carefully ensure all wire connections and polarities are correct and secure before applying power, otherwise this controller will be damaged.

• Connect with dimmable LED light

• Connect with Triac dimmable LED driver

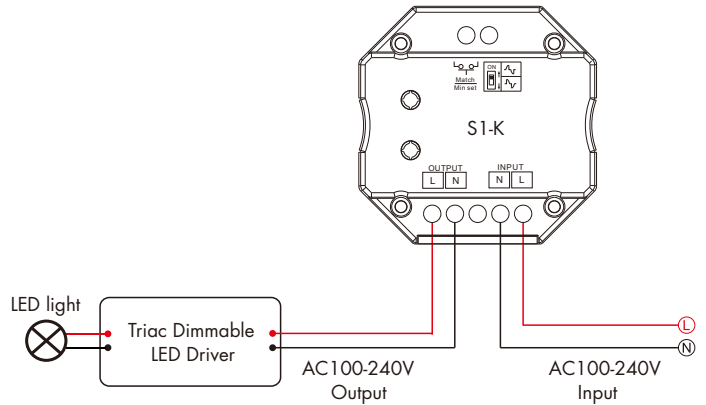
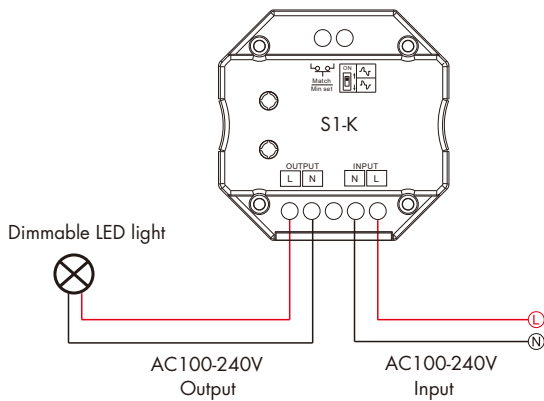

Note: When calculating the maximum number of load lamps or drivers, the input power or input current parameters of a single lamp or driver must be used, the output power parameters can not be used. In addition, the maximum surge current of the dimmer is 65A, the sum of surge current of multiple dimmable LED drivers should not exceed 2 times. otherwise, the product will be overloaded and damaged.

Leading Edge or Trailing Edge Dimming Setting

Select leading edge(forward-phase) dimmer or trailing edge(reverse-phase) dimmer according to dimmable LED light or driver.

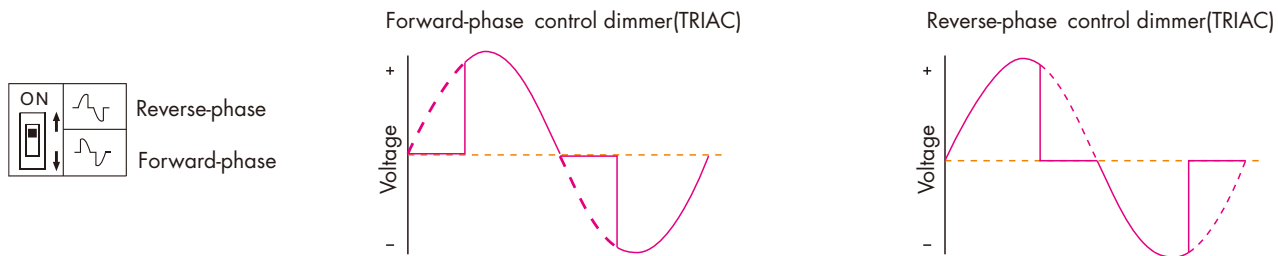

Caution: before power on, you must confirm the selection of dip switch.

Min Brightness Setting

Long press Min set key for 2s, the light blink 2 times, ready for min brightness set, then short press Min set key 1-6 times, to get 6 min brightness: 5%, 10%, 15%, 20%, 25% or 30%, the light will output the current min brightness immediately, Long press Min set key for 2s or wait 8s, quit min brightness set, the light will output 100% brightness automatically.

Light On/Off Fade Time

Long press Match key 5s, then short press Match key 3 times, the light on/off time will be set to 3s, the indicator light blink 3 times. Long press Match key 10s, restore factory default parameter, the light on/off time also restore to 0.5s.

Match Remote Control (Three Match Ways)

The AC triac rotary panel dimmer can also match with the RF dimming remote (optional). End user can choose the suitable match/delete ways. Three options are offered for selection:

Use Match key

Match: Short press Match key, immediately press on/off key(single zone remote) or zone key(multiple zone remote) of the remote. Delete: Press and hold Match key for 5s to delete all match, The light blinks 5 times means all matched remotes were deleted.

Use Knob

Match: Turn on light, turn off, immediately push the knob for 5s, then press on/off key (single zone remote) or zone key (multiple zone remote) of the RF remote within 5s. The LED indicator fast flash 3 times means match is successful.

Delete: Turn on light, turn off, immediately push the knob for 10s to delete all match, The LED indicator fast flash 6 times means all matched remotes were deleted.

Use Power Restart

Match: Switch off the power, then switch on power, repeat again, immediately short press on/off key (single zone remote) or zone key (multiple zone remote) 3 times on the remote. The light blinks 3 times means match is successful.

Delete: Switch off the power, then switch on power, repeat again, immediately short press on/off key (single zone remote) or zone key (multiple zone remote) 5 times on the remote. The light blinks 5 times means all matched remotes were deleted.

Statement

FCC Statement:

This device complies with Part 15 of the FCC Rules. operation is subject to the following two conditions:

- (1) this device may not cause harmful interference, and
- (2) this device must accept any interference received, including interference that may cause undesired operation.

IC Statement: This Class B digital apparatus complies with Canadian ICES-003. (Cet appareil numérique de la Classe B conforme à la norme NMB-003 du Canada).