

SS-A

RF Converter

2-Switch to RF Converter

- 1 or 2 push switch or normal switch input, RF signal output.
- Match with one or more RF LED controllers or RF dimming LED driver.
- To control 1 or 2 zone RF switch,
single color, dual color, RGB, RGBW or RGB+CCT LED light.
- Adopt 2.4GHz wireless technology, remote distance up to 30m.
- Used with the wall switch, suitable to insert standard panel bottom box.
- Low power design, energy-saving.



CE RoHS RED

Technical Parameters

Input and Output		Environment		Safety and EMC	
Input voltage	100-240VAC	Operation temperature	Ta: -20°C ~ +55°C	EMC standard	ETSI EN 301 489-1 V2.2.3 ETSI EN 301 489-17 V3.2.4
Input current	0.01A	IP rating	IP20	Safety standard	EN 61347-1:2015+A1:2021 EN 61347-2-13:2014+A1:2017
Output signal	RF 2.4G	Package		Radio Equipment	ETSI EN 300 328 V2.2.2
		Size	L60 x W60 x H40mm	Certification	CE RED
		Gross weight	0.061kg		

Mechanical Structures and Installations

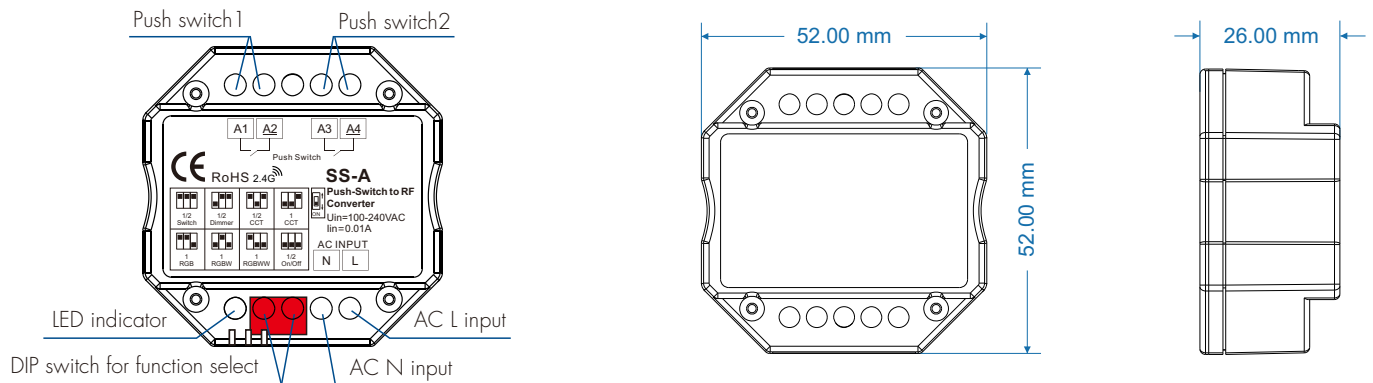

Wiring Diagram

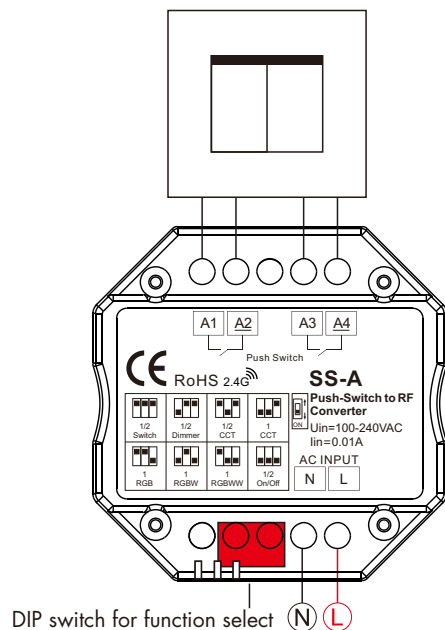

When work as 1/2 on/off switch RF remote controller, connect general on/off switch.

When work as the other function RF remote controller, connect push switch.

Note:

Input AC or DC power into the push switch port will damage the product.

Match guide

End user can choose the suitable match/delete ways. Two options are offered for selection:

Use the controller's Match key

Match:

Short press match key,
then short click the wall switch within 5s.
The LED indicator fast flash a few times means match is successful.

Delete:

Press and hold match key for 5s to delete all match,
the LED indicator fast flash a few times means all matched remotes
were deleted.

Use Power Restart









Match:

Switch off the power of the receiver, then switch on power, repeat again.
Immediately short click the wall switch 3 times quickly.
The light blinks 3 times means match is successful.

Delete:

Switch off the power of the receiver, then switch on power, repeat again.
Immediately short click the wall switch 5 times quickly.
The light blinks 5 times means all matched remotes were deleted.

Remote function select guide

 1/2 Switch	Connect push switch, 1 or 2 zone control, apply for RF switch or 1-5 color LED light which only need on/off function.
 1/2 Dimmer	Connect push switch, 1 or 2 zone control, apply for single color LED dimming.
 1/2 CCT	Connect push switch, 1 or 2 zone control, apply for dual color LED light (warm white + cold white) which with no need to adjust color temperature frequently.
 1 CCT	Connect push switch, 1 zone control, apply for dual color LED light (warm white + cold white).
 1 RGB	Connect push switch, 1 zone control, apply for RGB LED light.
 1 RGBW	Connect push switch, 1 zone control, apply for RGBW LED light.
 1 RGBWW	Connect push switch, 1 zone control, apply for RGB+CCT 5-color LED light.
 1/2 On/Off	Connect general on/off switch, 1 or 2 zone control, apply for RF switch or 1-5 color LED light which only need on/off function.

Operation

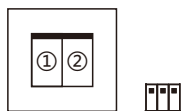

1/2 zone switch

① • Short click turn on/off 1 zone light.

② • Short click turn on/off 2 zone light.

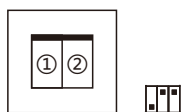

1/2 zone dimmer

① • Short click turn on/off 1 zone light.
• Click hold 1-6s to adjust brightness continuously.

② • Short click turn on/off 2 zone light.
• Click hold 1-6s to adjust brightness continuously.

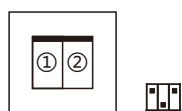

1/2 zone CCT

① • Short click turn on/off 1 zone light.
• Click hold 1-6s to adjust brightness continuously.
• Double click ready for color temperature adjustment,
then short click get 11 levels color temperature, or click hold 1-6s to adjust color temperature continuously.
Double click again or after 10s, quit color temperature adjustment.

② • Short click turn on/off 2 zone light.
• Click hold 1-6s to adjust brightness continuously.
• Double click ready for color temperature adjustment,
then short click get 11 levels color temperature, or click hold 1-6s to adjust color temperature continuously.
Double click again or after 10s, quit color temperature adjustment.

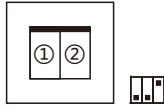

1 zone CCT

- ①
 - Short click turn on/off light.
 - Click hold 1-6s to adjust brightness continuously.
- ②
 - Short click get 11 levels color temperature.
 - Click hold 1-6s to adjust color temperature continuously.

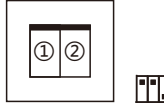

1 zone RGB

- ①
 - Short click turn on/off light.
 - Click hold 1-6s to adjust brightness continuously.
- ②
 - Short click run next dynamic mode.
 - Click hold to adjust RGB static color continuously.
 - When run dynamic mode, double click ready for speed adjustment, short click get 10 levels speed, click hold 2s get the default speed. Double click again or after 10s, quit speed adjustment.
 - When run RGB static color, double click ready for saturation adjustment, short click get 11 levels saturation, click hold 1-6s to adjust saturation continuously. Double click again or after 10s, quit saturation adjustment.

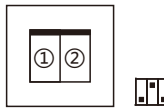

1 zone RGBW

- ①
 - Short click turn on/off light.
 - Click hold 1-6s to adjust RGB brightness continuously.
 - Double click ready for dynamic mode or static color mode adjustment, short click run next dynamic mode, click hold to adjust RGB static color continuously. Double click again or after 10s, quit mode adjustment.
- ②
 - Short click turn on/off white light.
 - Click hold 1-6s to adjust white brightness continuously.
 - When run dynamic mode, double click ready for speed adjustment, short click get 10 levels speed, click hold 2s get the default speed. Double click again or after 10s, quit speed adjustment.
 - When run RGB static color, double click ready for saturation adjustment, short click get 11 levels saturation, click hold 1-6s to adjust saturation continuously. Double click again or after 10s, quit saturation adjustment.

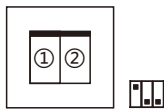

1 zone RGBWW
(RGB+CCT)

- ①
 - Short click turn on/off light.
 - Click hold 1-6s to adjust brightness continuously.
 - Double click ready for dynamic mode or static color mode adjustment, short click run next dynamic mode, click hold to adjust RGB static color continuously. Double click again or after 10s, quit mode adjustment.
- ②
 - Short click get 11 levels color temperature.
 - Click hold 1-6s to adjust WW/CW brightness continuously.
 - When run dynamic mode, double click ready for speed adjustment, short click get 10 levels speed, click hold 2s get the default speed. Double click again or after 10s, quit speed adjustment.
 - When run RGB static color, double click ready for saturation adjustment, short click get 11 levels saturation, click hold 1-6s to adjust saturation continuously. Double click again or after 10s, quit saturation adjustment.

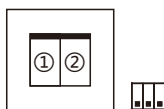

1/2 zone On/Off switch

- ①
 - Short click up to turn off 1 zone light.
 - Short click down to turn on 1 zone light.
- ②
 - Short click up to turn off 2 zone light.
 - Short click down to turn on 2 zone light.

Safety information

1. The product shall be installed and serviced by a qualified person.
2. This product is non-waterproof. Please avoid the sun and rain.
3. Ensure all wire connections and polarities are correct and secure before applying power to avoid any damages to the LED lights.
4. If a fault occurs please return the product to your supplier. Do not attempt to fix this product by yourself.