

Profil LED TWIN

- 1 - profil LED TWIN
- profil LED TWIN Plus
- 2 - taśma LED
górné/dolné podświetlenie
- 3 - wkręt dociskowy M4
- 4 - szyba o grubości max 8mm
- 5 - przewód

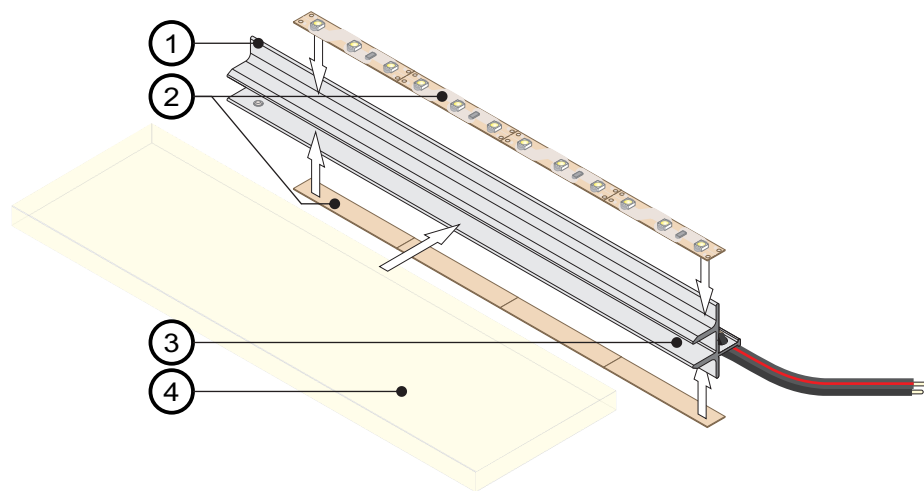

ZASTOSOWANIE

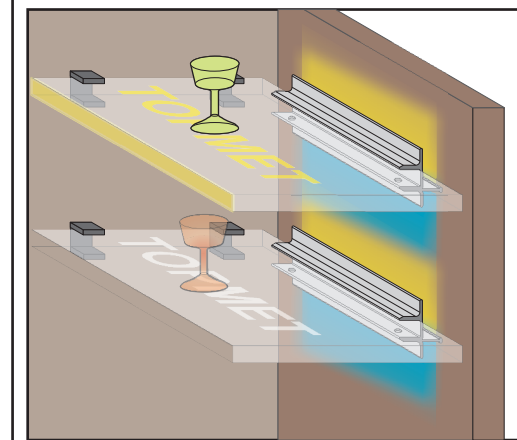

PROFIL LED TWIN

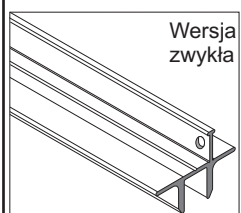

Wersja zwykła

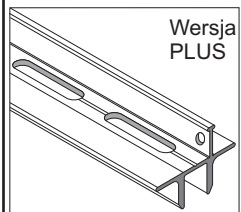

Wersja PLUS

Długość profilu:
500mm 1000mm 2000mm

TAŚMY LED

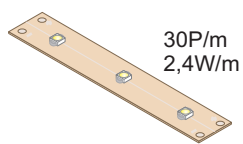

30P/m
2,4W/m

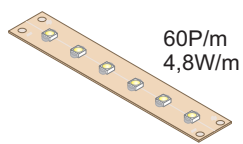

60P/m
4,8W/m

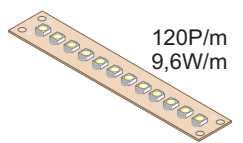

120P/m
9,6W/m

Mocowanie taśmy LED do profilu

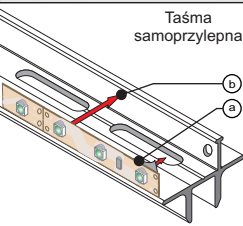

Taśma samoprzylepna

MOCOWANIE NA SZYBIE

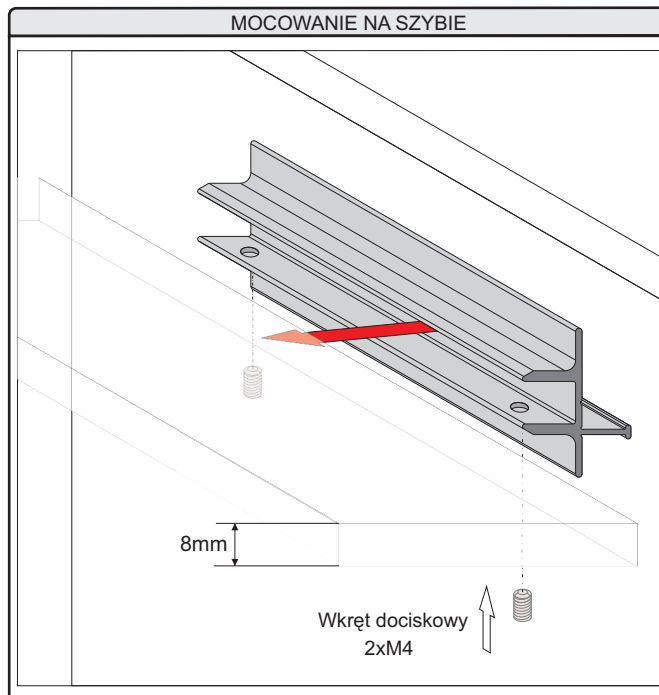

Wkręt dociskowy 2xM4

PRZEWÓD / WTYCZKA / KONEKTOR

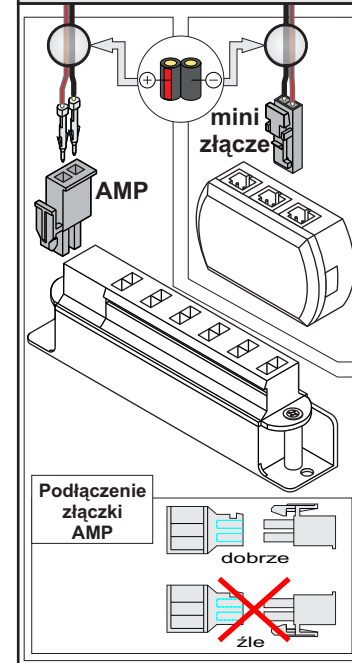

Podłączenie złączki AMP

dobrze
złe

TRANSFORMATORY

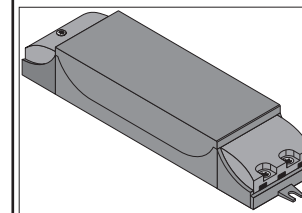

transformator LED 10W
transformator LED 25W
transformator LED 60W

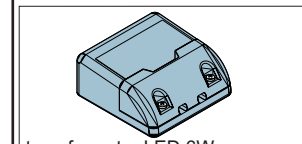

transformator LED 6W

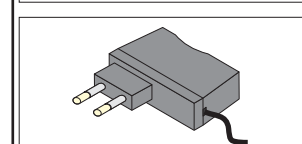

transformator LED 12W

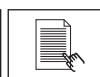

PROFESJONALNE OŚWIETLENIE