



Mi·Light Subordinate New Brand

## 6W RGB+CCT LED Garden Light+Power Cable Kit

Model No.: FUTC08A

### 1. Features

- RGB+CCT 16 Millions of colors to choose
- Signal transmitting & Modes synchronization
- Remote control Control distance 30m
- Color temperature 2700~6500K
- Waterproof and dustproof grade IP66
- Smart phone APP control (2.4GHz gateway is needed)
- Dimmable Saturation control
- 2.4G RF wireless transmission technology
- Support third party voice control (2.4GHz gateway is needed)
- Beam angle 25° Illumination distance more than 10m

### 2. Parameters

#### RGB+CCT LED Garden Light (DC24V)

- Input Voltage: DC24V
- CRI: >80
- Power: 6W
- Beam Angle: 25°
- Working Temp.: -20~45°C
- Illumination Distance: >10m
- Color Temp.: 2700K~6500K
- IP Rate: IP66
- Luminous Flux: 550LM
- RF: 2.4GHz
- Light Efficiency: 90LM/W
- Transmitting Power: 6dBm
- Lifespan: 50000 hours
- Control Distance: 30m

#### Switching Power Supply

- Input Voltage: AC100~240V 50/60Hz
- Rated Input Current: 1.5A Max.
- Power Consumption(no loading): 0.21W Max.
- Configuration: II Conductor
- Output Voltage: DC24V
- Rating Load Current: 2.7A
- Rating Output Power: 65W
- Working Temp.: 0~45°C
- Storage Temp.: -20~80°C

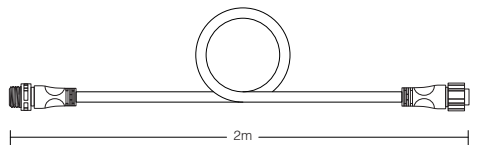
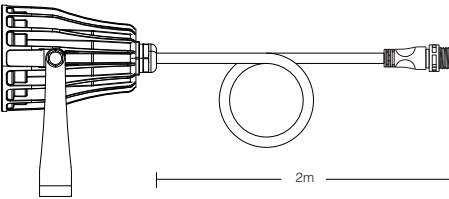
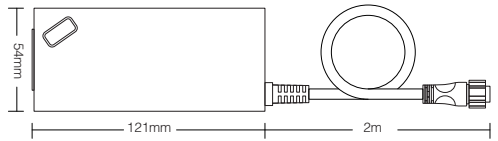
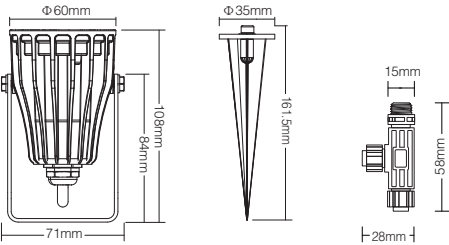

www.futlight.com  
Made in China



Signal transmitting & Modes synchronization

### 3. Connection Diagram

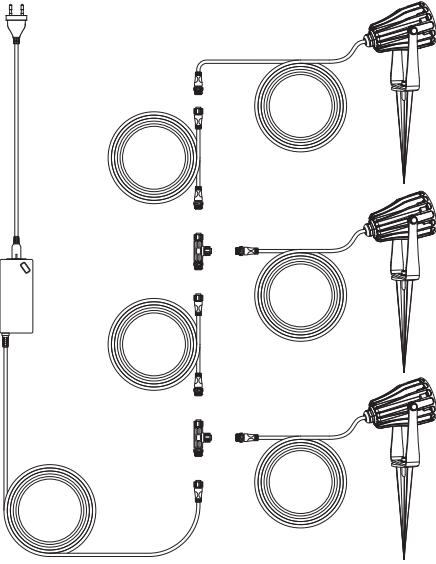

### 4. Link/Unlink

Compatible with these remote controls (Purchased separately)

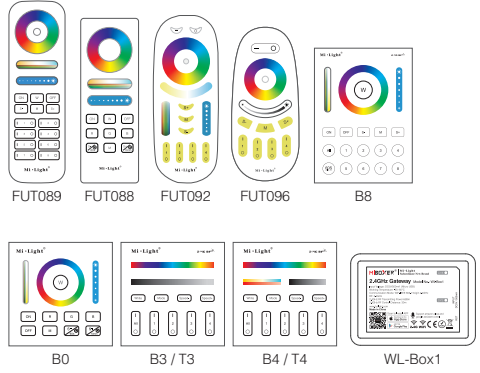

#### ⚠️ NOTE:

Lighting can be working after linking with remote; for more details, pls read the remote instruction.

### 5. Signal transmitting

One garden light can transmit the signals from the remote control to another garden light within 30m, as long as there is a garden light within 30m, the remote control distance can be limitless.

### 6. Modes synchronization

Different garden light can work synchronously when they are started at different times, controlled by the same remote, under same dynamic mode and within 30m distance.

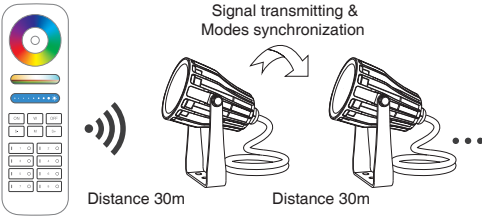









### 7. Dynamic Mode Sheet

Number	Dynamic Mode	Brightness / Saturation / Speed
1	Mardi Gras	Adjustable
2	Automatic color change	
3	Sam	
4	Gemstone	
5	Twilight	
6	American	
7	Fat Tuesday	
8	Party	
9	Slow Color Splash	

### 8. Attention

- When install the lighting fixtures, pls switch off the power to make sure the safety.
- Please check whether the input voltage supply is in accordance with the lighting fixtures.
- Non-professional user cannot dismantle the lighting fixtures directly, otherwise it may damage the lighting fixtures.
- Please do not use lighting fixtures around the mental area and high magnetic field, otherwise, it will badly affect the control distance.
- Users must be correct, strict and solid to install the lighting fixtures; do not use the lighting fixtures on strenuous vibration area.
- The lighting fixtures will be heating on working, pls do not cover the lighting housing.

### 9. Packing list

Name								
Quantity	3 PCS	3 PCS	1 PC	1 PC	2 PCS	2 PCS	1 PC	1 PC