

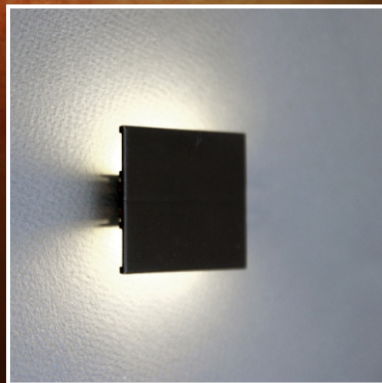



**profil LED
BACK**

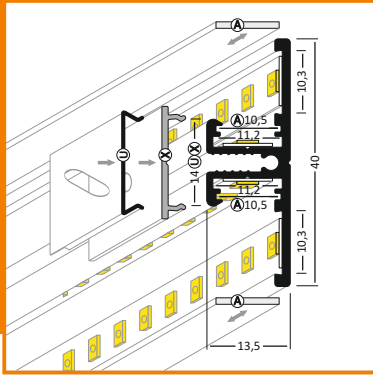

Profil LED specjalny

profil LED BACK A/UX



UE Patent No. 001321790-0009

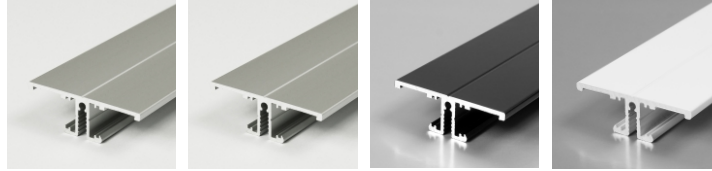

aluminium surowy
1000mm 90020000
2000mm 90030000

anodowany
1000mm 90020020
2000mm 90030020

czarny malowany
1000mm 90020002
2000mm 90030002

biały malowany
1000mm 90020001
2000mm 90030001

montaż na płasko do ściany lub mebla,
można użyć uchwytów SU/GR/CO;
dwukierunkowa tyna światła;
oświetlenie dekoracyjne

standardowe długości: 1000, 2000mm;
max. długość: 4000mm;
długość powyżej 2000mm - odbiór własny

klosze

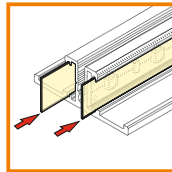
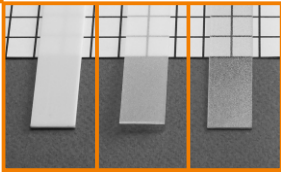

k l o s z e
w s u w a n y A

1000mm	1000mm	1000mm
89060038	89060039	89060016
2000mm	2000mm	2000mm
89070038	89070039	89070016

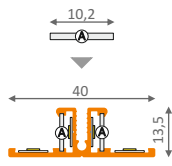

zaślepki

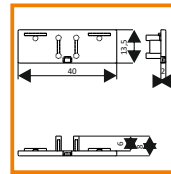
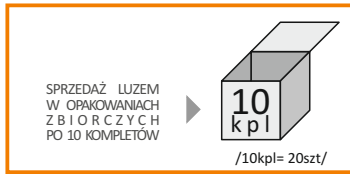
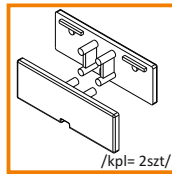
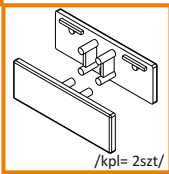

zaślepka BACK
srebrny ▶ 90110022
czarny ▶ 90110001
biały ▶ 90110002
szary ▶ 90110040

zaślepka BACK z otworem
▶ 90160022
▶ 90160001
▶ 90160002
▶ 90160040

zaślepka BACK
▶ 90100022 (min.10x)
▶ 90100001 (min.10x)
▶ 90100002 (min.10x)
▶ 90100040 (min.10x)

zaślepka BACK z otworem
▶ 90150022 (min.10x)
▶ 90150001 (min.10x)
▶ 90150002 (min.10x)
▶ 90150040 (min.10x)

GRUBOŚĆ ZAŚLEPKI
ZWIĘKSZA DŁUGOŚĆ PROFILU

mocowanie

OPCJONALNE
MOCOWANIE:

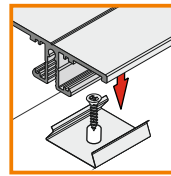
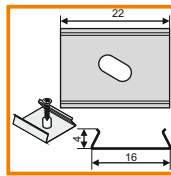
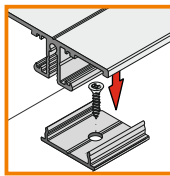
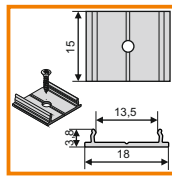

uchwyt X
76260000

uchwyt U sprężysty
76380000

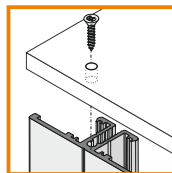
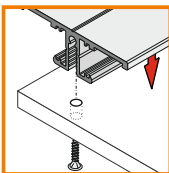

mocowanie za pomocą wkrętów

OPCJONALNY
ŁĄCZNIK:

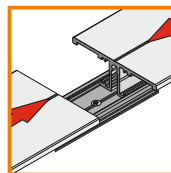
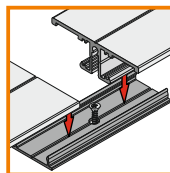
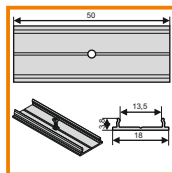

łącznik X
76350000

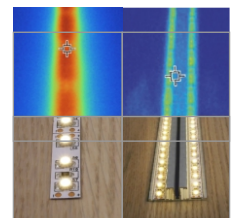

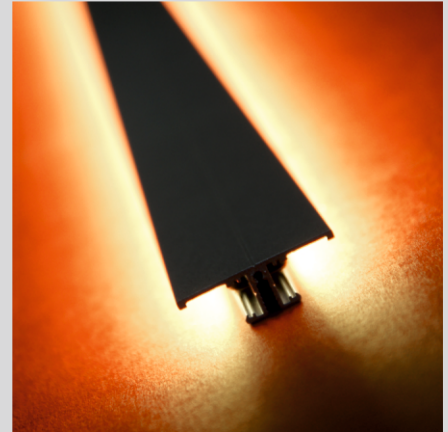
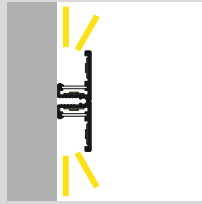
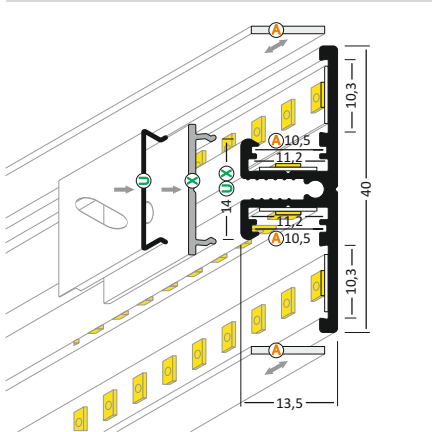

A cover A slide in
klosz A wsuwany

U¹ mounting plate U flexible
uchwyt U sprężysty

U² mounting plate U flexible cone
uchwyt U sprężysty cone

X mounting plate X
uchwyt X

lighting angle
kąty świecenia

mounting options
sposoby montażu

applications
zastosowania

