

# PEN12 CJ

## ROTATABLE DISPLAY LIGHTING SYSTEM

### OBROTOWY SYSTEM OŚWIETLENIA EKSPOZYCYJNEGO

- wall and furniture application
- various types of mounting brackets
- maximum LED strip width: 12 mm

- ścienny i meblowy
- różne typy mocowań
- maksymalna szerokość taśmy LED: 12 mm



### SIMILAR IN THE OFFER / PODOBNE W OFERCIE



PEN8  
I



CABI12  
E



CORNER10  
BC/UX



TRIO10  
BC



OVAL20  
BC



- J** slide cover  
klosz J wsuwany
- C** click cover  
klosz C klik
- C** lens cover  
klosz C soczewka

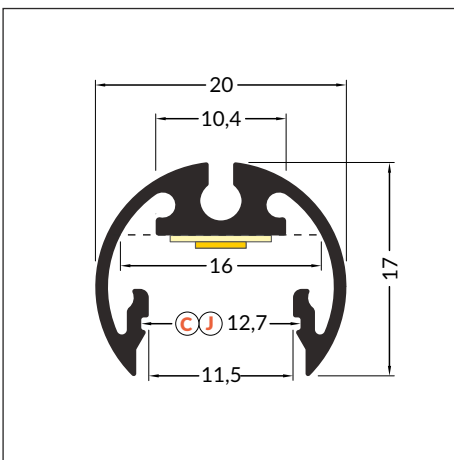
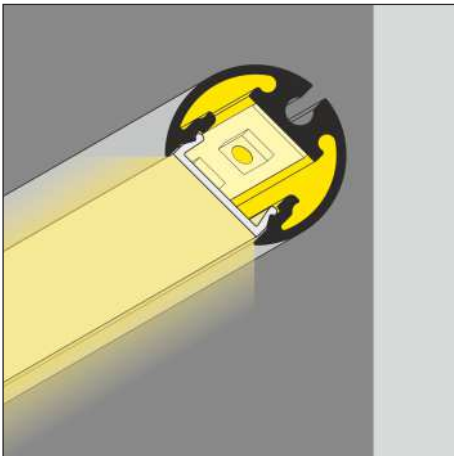
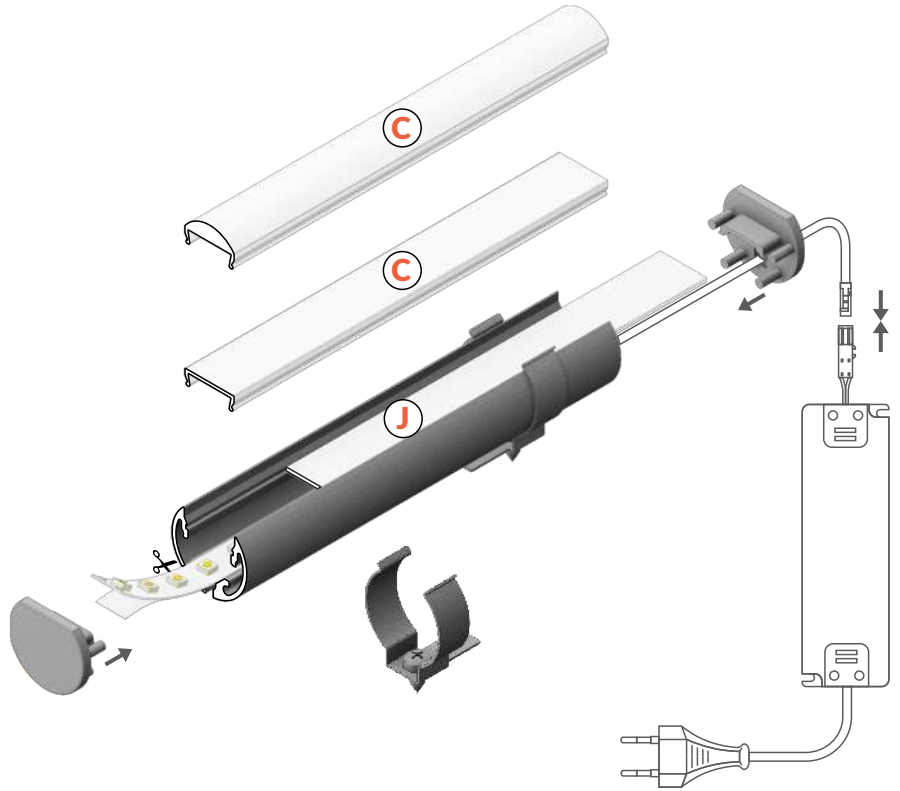

max 12 mm



special application  
specjalny



INDEX = 1 pc, length 2000 mm  
 package = 10 pcs  
 INDEKS = 1 szt., długość 2000 mm  
 opakowanie = 10 szt.

 white painted  
biały malowany  
F7000201



 anodized  
anodowany  
F7000220



 black painted  
czarny malowany  
F7000202

Available lengths: 1000 mm, 2000 mm, 3000 mm, 4000 mm.  
 The standard profile length tolerance is +20 mm.  
 More details >> 1.08.

Dostępne długości: 1000 mm, 2000 mm, 3000 mm, 4000 mm.  
 Standardowa tolerancja długości profili wynosi: +20 mm.  
 Więcej informacji >> 1.08.



## COVERS / KLOSZE

### J slide cover

colours: transparent, frosted, opal  
material: PC, PP, PP

klosz J wsuwany  
kolory: transparentny, szron, mleczny  
materiał: PC, PP, PP



**Note!** Dimensions of the space to install LED source  
**Uwaga!** Wymiary przestrzeni do zamontowania źródła LED

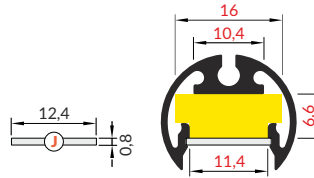

J transparent / J transparentny  
70330016

J frosted / J szron  
70330039

J opal / J mleczny  
70330038

### C click cover

colours: transparent, opal  
material: PMMA

klosz C klik  
kolory: transparentny, mleczny  
materiał: PMMA

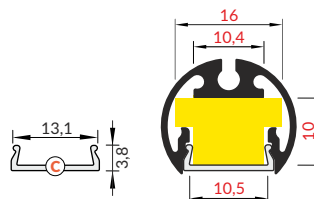

C transparent / C transparentny  
76330000

C opal / C mleczny  
76330038

### C lens click cover

colour: transparent  
material: PC

klosz C klik soczewka  
kolor: transparentny  
materiał: PC

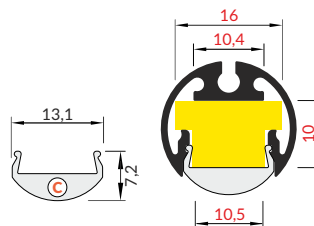

C lens / C soczewka  
76300000

The standard cover length tolerance is +20 mm.  
More details >> 1.08.

Standardowa tolerancja długości klosza wynosi: +20 mm  
Więcej informacji >> 1.08.

## ENDINGS / ZAŚLEPKI

### PEN12 ending

colours: white, silver, black, grey  
material: ABS

zaślepka PEN12  
kolory: biały, srebrny, czarny, szary  
materiał: ABS



Ending with marked space to bore the holes.  
Zaślepka z punktami do przewiercenia otworów.

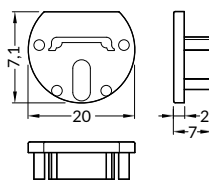

INDEX = 1 set  
package = 10 sets = 20 pcs  
INDEKS = 1 kpl  
opakowanie = 10 kpl = 20 szt.

white  
biały F7009901

silver  
srebrny F7009940

black  
czarny F7009902

grey  
szary F7009922

## MOUNTINGS / MOCOWANIA

### PEN12 flat holder

colour: inox  
material: stainless steel

uchwyt PEN12 płaski  
kolor: inox  
materiał: stal nierdzewna

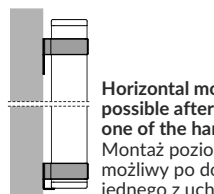
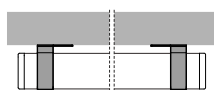

Horizontal mounting,  
possible after bending  
one of the handles.  
Montaż poziomy  
możliwy po docięciu  
jednego z uchwytów.



INDEX = 1 set  
package = 10 sets = 20 pcs  
INDEKS = 1 kpl  
opakowanie = 10 kpl = 20 szt.

inox  
inox F7009019



## MOUNTINGS / MOCOWANIA

**PEN12 stretcher holder**  
colour: chrome  
material: brass

uchwyt PEN12 rozporowy  
kolor: chrom  
materiał: mosiądz

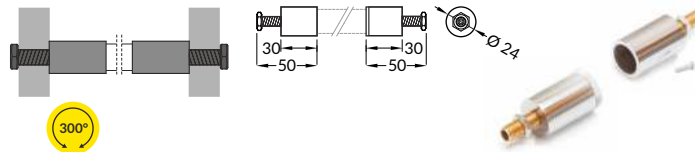

INDEX = 1 set = 2 pcs  
INDEKS = 1 kpl = 2 szt.

chrome  
chrom F7009103

**PEN12 ring holder**  
colours: chrome  
material: brass

uchwyt PEN12 ring  
kolory: chrom  
materiał: mosiądz

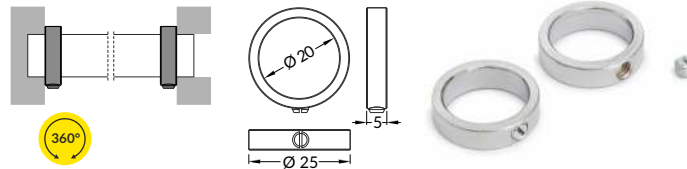

INDEX = 1 set = 2 pcs  
INDEKS = 1 kpl = 2 szt.

chrome  
chrom F7009203

**PEN12 double holder with thread**  
colour: chrome  
material: steel, brass

uchwyt PEN12 podwójny z gwintem  
kolor: chrom  
materiał: stal, mosiądz

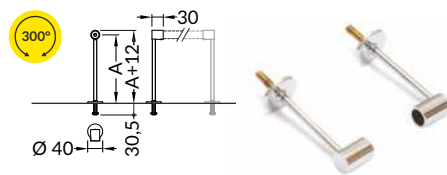

INDEX  
= 1 set = 2 pcs  
INDEKS  
= 1 kpl = 2 szt.

A =  
100 mm F7009303  
200 mm F7009403  
300 mm F7009503

**PEN12 double holder with soffit ceiling**  
colour: chrome  
material: steel, brass

uchwyt PEN12 podwójny z podsufitką  
kolor: chrom  
materiał: stal, mosiądz

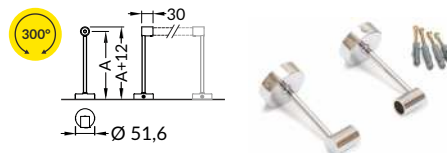

INDEX  
= 1 set = 2 pcs  
INDEKS  
= 1 kpl = 2 szt.

A =  
100 mm F7009603  
200 mm F7009703  
300 mm F7009803

**PEN12 wall-mounted extension arm**  
colours: white, silver, black  
material: steel, brass

uchwyt PEN12 wysięgnik ścienny  
kolory: biały, srebrny, czarny  
materiał: stal, mosiądz

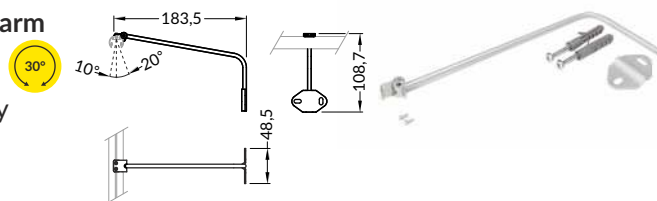

INDEX = 1 set = 1 pc  
INDEKS = 1 kpl = 1 szt.

white  
biały F7008801  
 silver  
srebrny F7008822  
 black  
czarny F7008802

**PEN12 cabinet-mounted extension arm**  
colours: white, silver, black  
material: steel, brass

uchwyt PEN12 wysięgnik nadszafkowy  
kolory: biały, srebrny, czarny  
materiał: stal, mosiądz

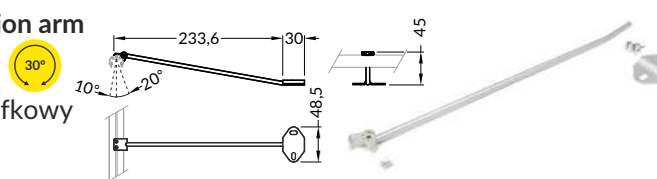

INDEX = 1 set = 1 pc  
INDEKS = 1 kpl = 1 szt.

white  
biały F7008901  
 silver  
srebrny F7008922  
 black  
czarny F7008902

