

Wall Mounted Touch Panel

Model No.: T11, T12, T13, T14

4 Zone/1-4 color/Glass touch panel/Color wheel/AC input/DMX 512 and RF 2.4G signal output



CE RoHS  LVD RED

Features

- Touch panel 4 zone 1-4 color DMX512 master, can also be used as 4 zone 1-4 color RF remote.
- DMX signal output, comply to standard DMX512 protocol, compatible with DMX decoder from any supplier.
- When used as RF remote, each zone can remote control multiple RF 2.4G LED controllers.
- Ultra sensitive high strength glass touch panel with touch color wheel in the middle.
- Smooth and accurate color adjustment by touching the color wheel.
- Touch keys with LED indicator.
- White & Black glass panel available.

Technical Parameters

Model No.	T11	T12	T13	T14
Light type	Single color	Dual color	RGB	RGBW
Output DMX channel number	4	8	12	16

Input and Output	
Input voltage	100-240VAC
Input current	Max 0.1A
Output signal	DMX512, RF 2.4GHz

Dimming data	
Input signal	Touch key + RF 2.4GHz
RF Control distance	10m[Barrier-free space]
Dimming level	256 levels
Dimming range	0-100%

Safety and EMC	
EMC standard [EMC]	ETSI EN 301 489-1 V2.2.3 ETSI EN 301 489-17 V3.2.4
Safety standard [LVD]	EN 62368-1:2020+A11:2020
Radio Equipment [RED]	ETSI EN 300 328 V2.2.2
Certification	CE, EMC, LVD, RED

Environment	
Operation temperature	Ta: -30°C ~ +55°C
Case temperature [Max.]	Tc: +65°C
IP rating	IP20

Warranty	
Warranty	5 years

Weight	
Net weight	0.181kg
Gross weight	0.234kg

Mechanical Structures and Installations

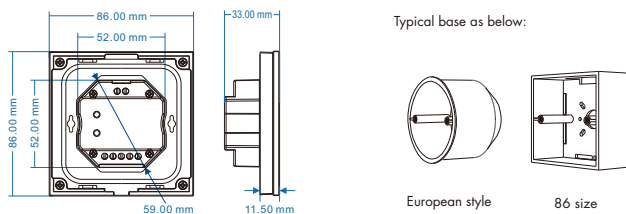
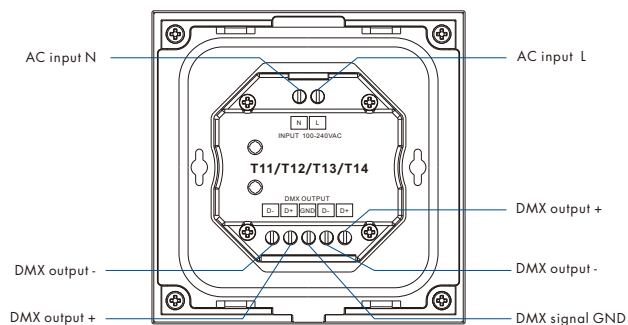

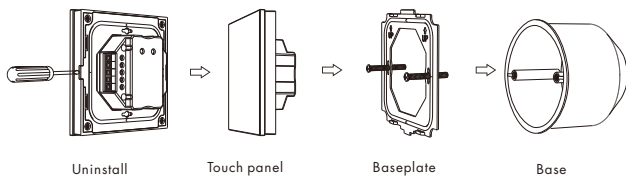

Installation diagram:



Key function

T11 Single color panel



-  Turn on/off all zone light.
-  Brightness, 10 levels.
-  Brightness wheel.

1 2 3 4

Short press turn on zone light and select zone simultaneously, long press 2s turn off zone light. 4 zone control separately or synchronously, each zone could control multiple receivers.

T12 Dual color panel

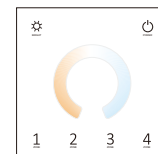







-  Turn on/off all zone light.
-  Brightness, 10 levels.
-  Color temperature wheel.

1 2 3 4

Short press turn on zone light and select zone simultaneously, long press 2s turn off zone light. 4 zone control separately or synchronously, each zone could control multiple receivers.

T13 RGB panel



-  Turn on/off all zone light.
-  Color wheel.
-  Short press play 10 built-in dynamic mode, long press 2s run mode-cycle.
-  Adjust dynamic mode speed or RGB color saturation, 10 levels.
-  Adjust brightness, 10 levels.
-  Short press replay scene. Long press 2s to save the current color into the scene.

1 2 3 4

Short press turn on zone light and select zone simultaneously, long press 2s turn off zone light. 4 zone control separately or synchronously, each zone could control multiple receivers.

T14 RGBW panel

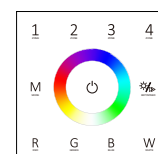

-  Turn on/off all zone light.
-  Color wheel.
-  Short press play 10 built-in dynamic mode, long press 2s run mode-cycle.
-  Adjust dynamic mode speed or static color brightness, 10 levels.
-  Short press get red, green, blue, white color, long press adjust each color brightness.

1 2 3 4

Short press turn on zone light and select zone simultaneously, long press 2s turn off zone light. 4 zone control separately or synchronously, each zone could control multiple receivers.

Turn on key tone: Long press power key for 5s when all zone-light is off, will turn on or turn off key tone.

Touch Panel work as DMX512 Master

After connect with DMX decoders, please set the DMX decoders address as below:

Model No.	T11			T12			T13			T14		
	W	V	C	W	C	R	G	B	R	G	B	W
Zone 1 DMX decoder's address	1	1	2	1	2	3	1	2	3	4		
Zone 2 DMX decoder's address	2	3	4	4	5	6	5	6	7	8		
Zone 3 DMX decoder's address	3	5	6	7	8	9	9	10	11	12		
Zone 4 DMX decoder's address	4	7	8	10	11	12	13	14	15	16		

Wiring Diagram for touch panel work as DMX512 master

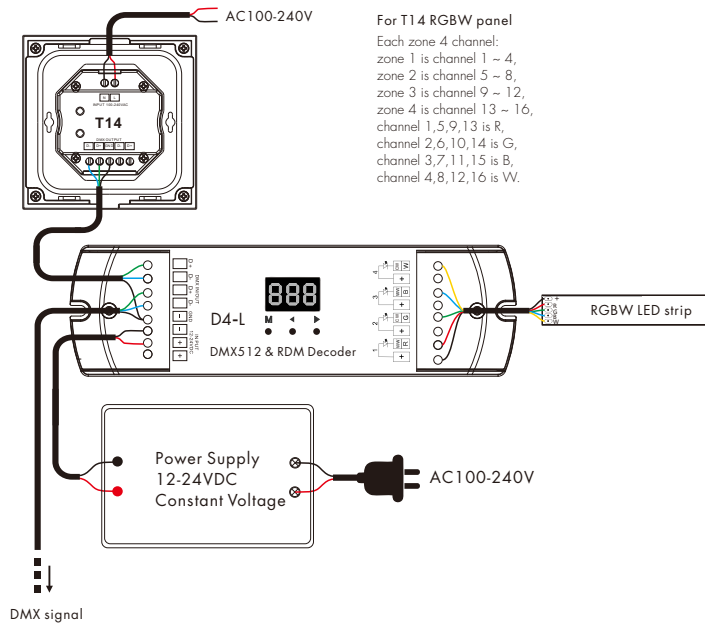

Touch Panel work as DMX512 master match RF remote

Touch panel 4 zone DMX512 master can also match with 4 zone RF remote [Optional].

End user can choose the suitable match/delete ways. Two options are offered for selection:

Use On/Off key

Match:

Turn on light, turn off, immediately press the On/Off key of the panel for 5s, then press any zone key of the RF remote within 5s. The LED indicator fast flash 3 times means match is successful.

Delete:

Turn on light, turn off, immediately press the On/Off key of the panel for 10s to delete all match. The LED indicator fast flash 6 times means all matched remotes were deleted.

Touch Panel work as RF remote

Touch panel 4 zone remote can match with RF controller for the corresponding light type.

End user can choose the suitable match/delete ways. Two options are offered for selection:

Use the controller's Match key

Match:

Short press match key, immediately press zone key of the touch panel. The LED indicator fast flash a few times means match is successful.

Delete:

Press and hold match key for 5s to delete all match. The LED indicator fast flash a few times means all matched remotes were deleted.

Use Power Restart

Match:

Switch off the power of the panel, then switch on power, repeat again. Immediately short press any zone key 3 times on the remote. The LED indicator fast flash 3 times means match is successful.

Delete:

Switch off the power of the panel, then switch on power, repeat again. Immediately short press any zone key 5 times on the remote. The LED indicator fast flash 6 times means all matched remotes were deleted.

Use Power Restart

Match:

Switch off the power of the receiver, then switch on power, repeat again. Immediately short press zone key 3 times on the touch panel. The light blinks 3 times means match is successful.

Delete:

Switch off the power of the receiver, then switch on power, repeat again. Immediately short press zone key 5 times on the touch panel. The light blinks 5 times means all matched remotes were deleted.

Wiring Diagram for touch panel work as RF remote

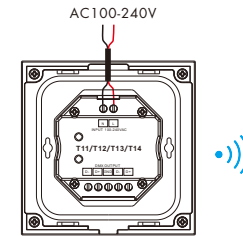

RGB/RGBW dynamic mode list (only for T13 / T14)

No.	Name	No.	Name
1	RGB jump	6	RGB fade in and out
2	RGB smooth	7	Red fade in and out
3	6 color jump	8	Green fade in and out
4	6 color smooth	9	Blue fade in and out
5	Yellow cyan purple smooth	10	White fade in and out

Malfunctions analysis & troubleshooting

Malfunctions	Causes	Troubleshooting
No light	1. No power. 2. Wrong connection or insecure.	1. Check the power. 2. Check the connection.
Wrong color	1. DMX decoder first address error. 2. Wrong connection of output wires.	1. Check the DMX first address. 2. Reconnect output wires.