

TL-K(WT)

Rotary Glass Panel WiFi 0/1-10V Dimmer

- Output 1 channel of 0/1-10V signal to control 0/1-10V dimmable LED driver.
- Rotate knob to change brightness, support push and long push operation.
- Tuya smart APP cloud control, support on/off, brightness adjust, delay turn on/off light, timer run, scene edit function.
- Voice control, support for Amazon Alexa, Google Assistant, Tmall Genie and Xiaodu voice assistant.
- High surge specification relay switch output, with over-zero detection function.
- White or black glass panel available.



CE RoHS

Technical Parameters

Input and Output		Dimming data		Safety and EMC	
Input voltage	AC100-240V	Input signal	WiFi + Rotary knob	EMC standard	EN IEC 55015 EN IEC 61547 ETSI EN 301 489-1/-3
Output signal	0/1-10V (50mA)	Dimming level	256 levels	Safety standard	EN 61347-1/-2
Output current	Max 3A (AC)	Dimming range	0-100%	Radio Equipmen	ETSI EN 300 440
Relay surge current	200A	Environment		Certification	CE RoHS
Package		Operation temperature	Ta: -20°C~ +55°C	Warranty	
Size	L112 xW112 x H60mm	Case temperature (Max.)	Tc: +65°C	Warranty	5 years
Gross weight	0.245kg	IP rating	IP20		

Mechanical Structures and Installations

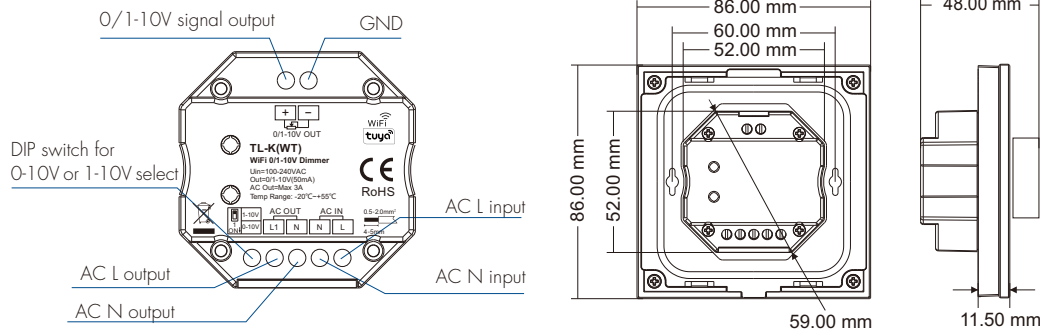

Typical base as below:



European style 86 size

Installation diagram:

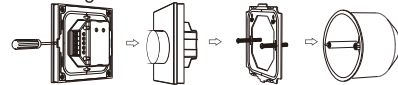

Uninstall Rotary panel Baseplate Base

Wiring Diagram

- Connect with 0/1-10V dimmable driver (no use AC OUT)

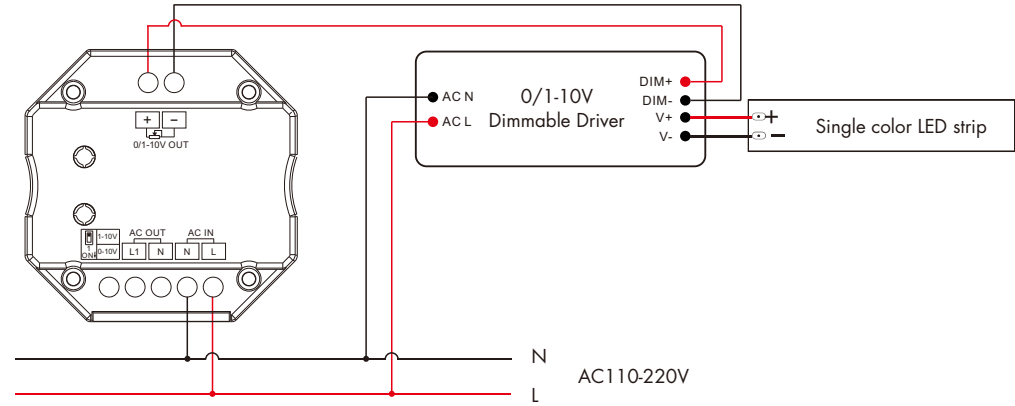

- Connect with 0/1-10V dimmable driver (use AC OUT)

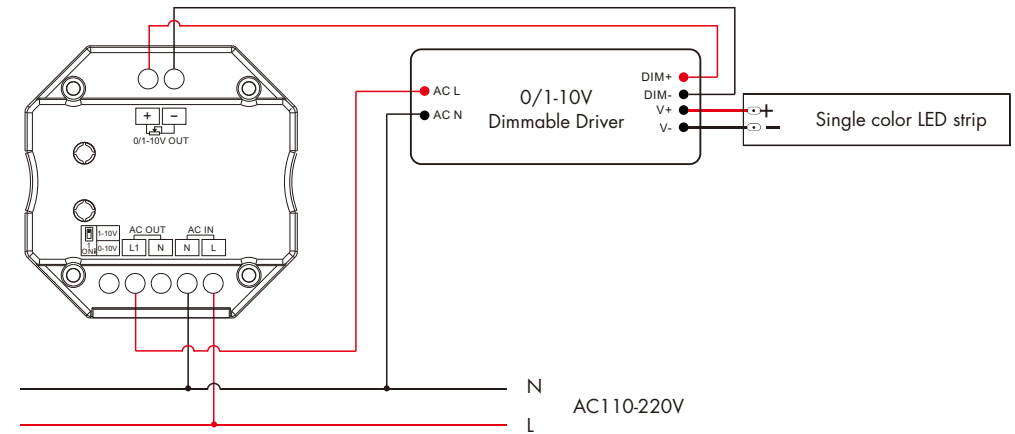

Note:

1. We recommend the number of LED drivers connected to 0/1-10V dimmer does not exceed 100 pieces, The maximum length of the wires from dimmer to LED driver should be no more than 50 meters.
2. The MAX. surge current of the AC OUT is 200A. When connecting multiple capacitive (LED power supplies) or inductive loads, the sum of the surge currents can not exceed its maximum value. Otherwise, long-term use may cause product damage.

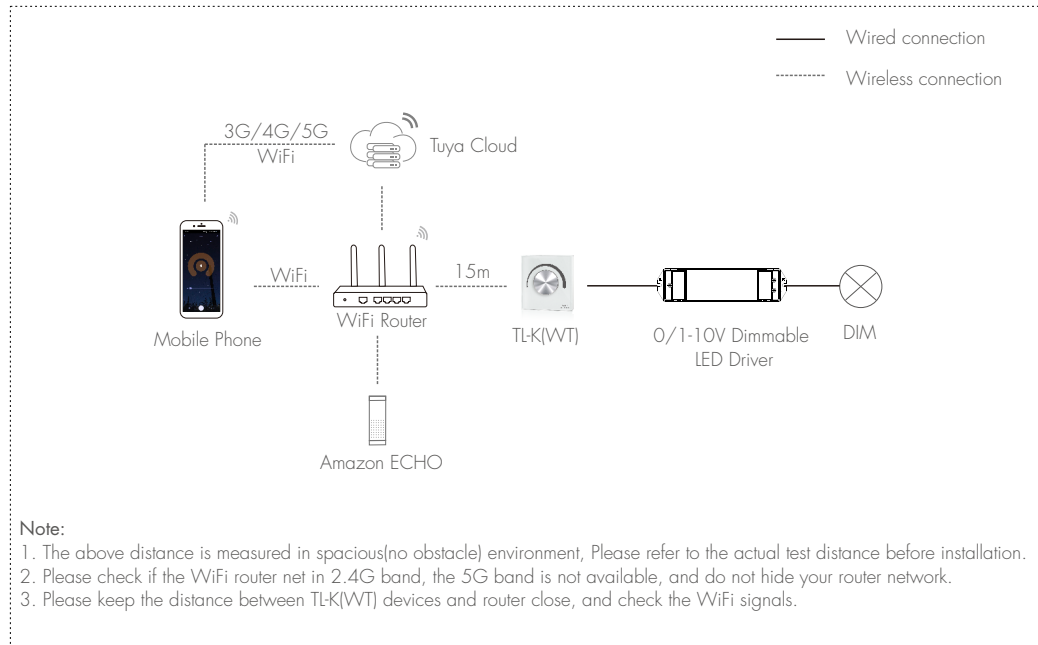

Knob Function

- Push: Turn on or off light.
- After turn on light:
 - Rotate: Rotate knob to adjust brightness, 2.5 turns, 50 levels.
 - Long push(1-6s): Continuous 256 levels brightness adjustment.

0-10V or 1-10V Dimming Setting

Select 0-10V dimmer or 1-10V dimmer according to dimmable LED driver.

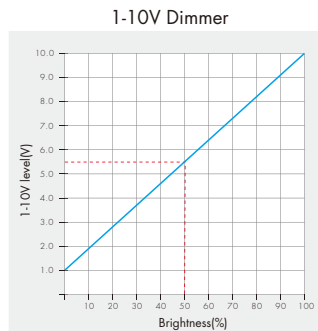
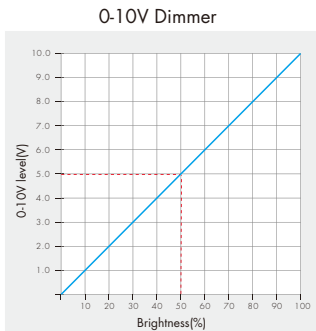

● Download and Open APP

Search for "Tuya Smart/Smart Life APP" in the APP store, or scan the QR code on the right to download the APP. Register and login after installation.



● APP Pairing Network

Below three methods are available to clear the previous network connection and enter Tuya WiFi config mode with RUN indicator flashing fast:

1. Dimmer power off and on for 5 consecutive times fastly.
2. Short press the knob to turn on/off the light 3 times fastly and immediately long press the knob for 5s.
3. The moment the dimmer is powered up, press and hold the knob for 5s.

If Tuya smart APP network connection succeed, the RUN indicator will stop flash, and in Tuya smart APP, you can find DIM device. When controlling the light with Tuya Smart/Smart Life APP, if the network connection is poor, you can control the light with Bluetooth connection within the Bluetooth control range. Note: The light can not be directly controlled by Bluetooth without WiFi configuration.

Tuya Smart APP Interface

White interface

Touch on/off key to turn on or off light, Touch brightness slide to adjust brightness.

Scene interface

The 1-4 scene is static color. the inner color of these scene can be editable.

Music, Timer, Schedule

The music play can use smart phone music player or micro-phone as music signal input. The Timer key can turn on or turn off light in the next 24 hours. The Schedule key can add multiple timers to turn on or turn off light according to different time periods.

