

TS-K(WZ)

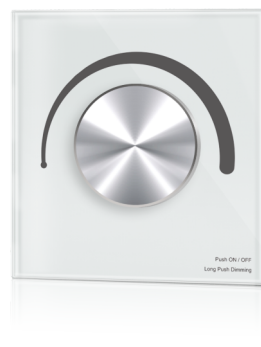

Rotary Glass Panel ZigBee Triac Dimmer

- Rotary glass panel ZigBee AC phase-cut dimmer, 1 channel output.
- Tuya smart APP cloud control, support on/off, brightness adjust, delay turn on/off light, timer run, scene edit function.
- Philips HUE APP control by connect with Philips HUE bridge.
- Voice control, support for Amazon Alexa, Google Assistant, Tmall Genie and Xiaodu voice assistant.
- To dim and switch single color dimmable LED lamps, traditional incandescent and halogen lights.
- Rotate knob to change brightness, support push and long push operation.
- 256 levels 0-100% dimming smoothly without any flash.
- Leading edge dimming or trailing edge dimming set by dip switch.
- Light on/off fade time 3s selectable.
- Over-heat / Overload protection, recover automatically.
- White & Black glass panel available.



CE RoHS

Technical Parameters

Input and Output		Dimming data		Safety and EMC	
Input voltage	AC100-240V	Input signal	ZigBee + Rotary knob	Safety standard	EN IEC 55015/EN IEC 61547 ETSI EN 301 489-1/-3/-17
Input current	1.5A	RF Control distance	15m(Barrier-free space)	EMC standard	EN 60669-1/-2
Output voltage	AC100-240V	Dimming level	256 levels	Radio Equipmen	ETSI EN 300 440 ETSI EN 300 328
Output current	1.5A	Dimming range	0-100%	Certification	CE RoHs
Output power	150-360W				
Warranty and Protection		Environment		Package	
Warranty	5 years	Operation temperature	Ta: -30 °C ~ +55 °C	Size	L112 x W112 x H60mm
Protection	Over-heat / Overload	Case temperature (Max.)	Tc: +85 °C	Gross weight	0.234kg
		IP rating	IP20		

Mechanical Structures and Installations

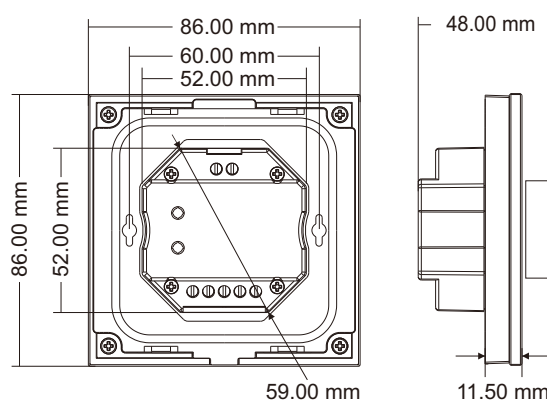
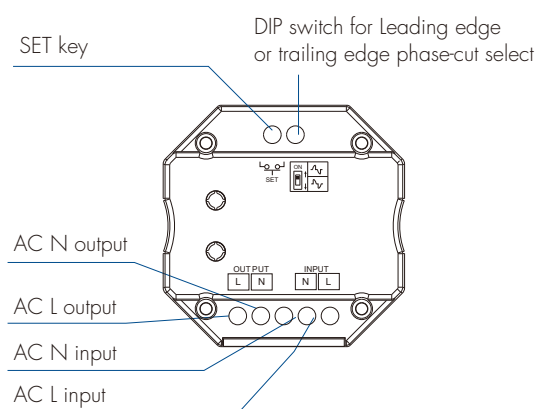

Installation diagram:

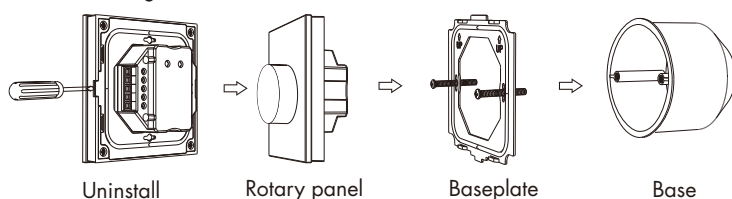

Typical base as below:

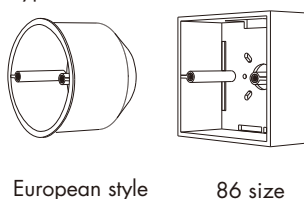

Knob Function

- Push: Turn on or off light.
After turn on light:
- Rotate: Rotate knob to adjust brightness, 2.5 turns, 50 levels.
- Long push(1-6s): Continuous 256 levels brightness adjustment.

Compatible Load Types

Load type	Maximum load	Remarks
Dimmable LED lamps	200W @ 220V 100W @ 110V	Due to variety of LED lamp designs, maximum number of LED lamps is further dependent on power factor result when connected to dimmer.
Triac dimmable LED drivers	200W @ 220V 100W @ 110V	Maximum permitted number of drivers is 200W divided by driver rated input power, and make sure the surge current is no more than 2 times 65A.
Incandescent lighting, HV halogen lamps	400W @ 220V 200W @ 110V	

Because different manufacturers triac dimmable LED driver rated input power is different, you can refer to the formula to calculate the max. number of LED driver. Formula: $D_{max} = 200W/RP$, at the same time need to meet the sum of the surge current (I_{surge}) does not exceed 130A. For example: triac dimmable LED driver rated input power(RP) = 15.4W, surge current = 10A/230VAC, Then $D_{max} = 200/15.4 = 13$ (pcs), $I_{surge} = 13 * 10 = 130A$, the max. number of triac dimmable LED driver is 13.

Recommended number of load connection

Load type	Output power per load	Quantity
Dimmable downlight	5.5W @ 220V~240V	20
Triac dimmable LED driver	12W @ 200V~240V	15
Triac dimmable LED driver	36W @ 200V~240V	4
Triac dimmable LED driver	75W @ 200V~240V	2

System Wiring

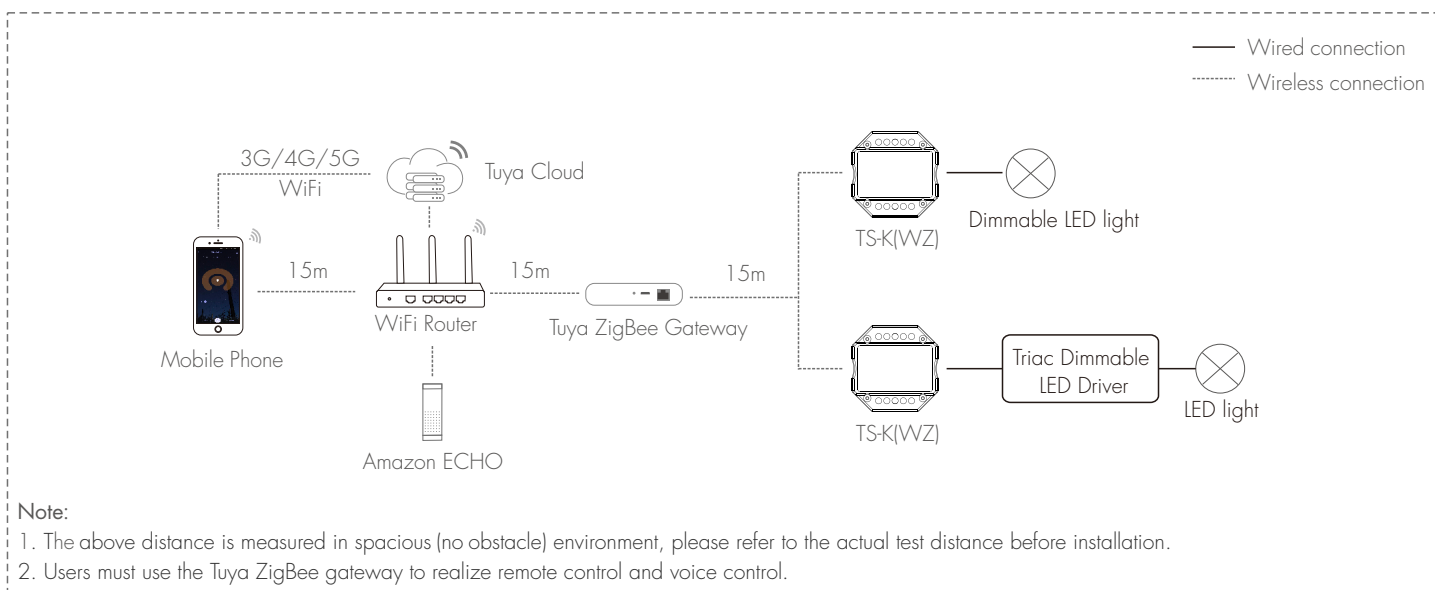

Wiring Diagram

⚠ Caution: Please carefully ensure all wire connections and polarities are correct and secure before applying power, otherwise this controller will be damaged.

• Connect with dimmable LED light

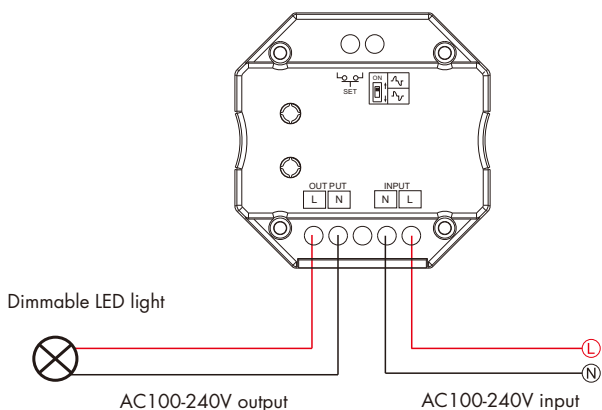

• Connect with Triac dimmable LED driver

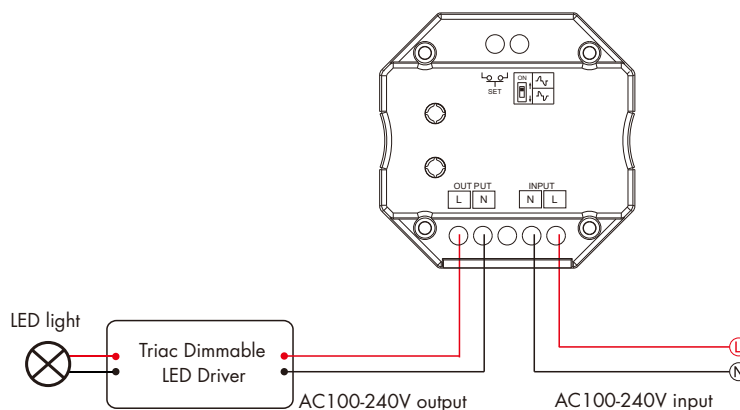

Min brightness setting

Long press SET key for 10s, the light blink 2 times, ready for min brightness set, then short press Min set key 1-6 times, to get 6 min brightness: 5%, 10%, 15%, 20%, 25% or 30%, the light will output the current min brightness immediately, wait 8s, quit min brightness set automatically, the light will return output 100% brightness.

Light on/off fade time

Long press SET key 15s, the indicator blinks 3 times, restore factory default parameter, the light on/off time also restore to 0.5s. Long press SET key 20s, the indicator blinks 4 times, the light on/off fade time is set to 3 s.

Select leading edge(forward-phase) dimmer or trailing edge(reverse-phase) dimmer according to dimmable LED light or driver.

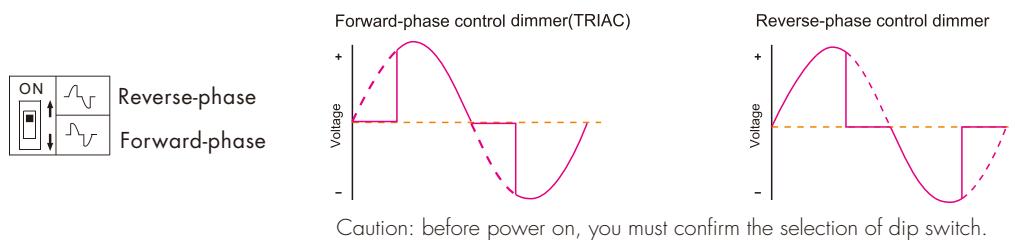

Tuya Smart APP Network Connection and Operation

Please download the corresponding Tuya smart/Smart life APP according to your region.

Five methods to clear the previous network connection, enter config mode, the LED indicator flash fastly 10 time.

1. Press and hold SET key for 5s.
2. Push twice SET key fastly.
3. Dimmer power off and on for 5 consecutive times fastly.
4. Short press the knob to turn on/off the light 3 times fastly and immediately long press the knob for 5s.
5. The moment the dimmer is powered up, press and hold the knob for 5s.

Under the ZigBee Gateway interface, search and add ZigBee devices, If Tuya smart APP network connection succeed, the indicator will stop flash, and in Tuya smart APP, you can find ZB3.0-DIM device.



Tuya Smart APP interface

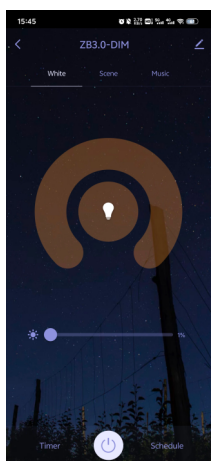

White interface
Click ☉, Turning lights on or off,
Touch brightness slide to adjust brightness.

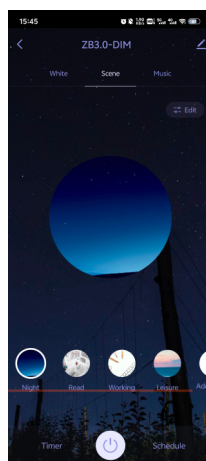

Scene interface
The 1-4 scene is static color.
the inner color of these scene can be editable

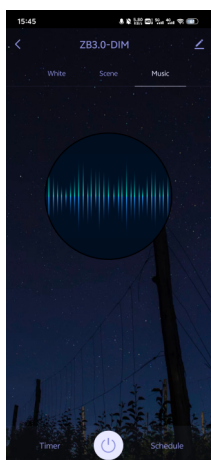

Music, Timer, Schedule
The music play can use smart phone music player or micro-phone as music signal input.
The Timer key can turn on or turn off light in the next 24 hours.
The Schedule key can add multiple timers to turn on or turn off light according to different time periods.