

# GROOVE10 BC/UX

## RECESSED ALUMINIUM PROFILE

### ALUMINIOWY PROFIL WPUSTOWY

- used mainly in furniture
- ceiling installation possible
- 6 types of covers
- maximum LED strip width: 10 mm
- głównie do zastosowania meblowego
- możliwe zastosowanie sufitowe
- 6 rodzajów kloszy
- maksymalna szerokość taśmy LED: 10 mm



## SIMILAR IN THE OFFER / PODOBNE W OFERCIE



DEEP10  
BC/UX



TRIO10  
BC



BEGTIN12  
J/S



UNI12  
BCD/U



GROOVE14  
EF/TY



**B** slide cover  
klosz B wsuwany

**C** click cover  
klosz C klik

**C** lens cover  
klosz C soczewka

**U**<sup>1</sup> U flexible mounting plate  
uchwyt U sprężysty

**U**<sup>2</sup> cone U flexible mounting plate  
uchwyt U sprężysty cone

**U**<sup>3</sup> rack U flexible mounting plate  
uchwyt U sprężysty rack

**X**<sup>1</sup> X mounting plate  
uchwyt X

**X**<sup>2</sup> spring X mounting plate  
uchwyt X sprężyna

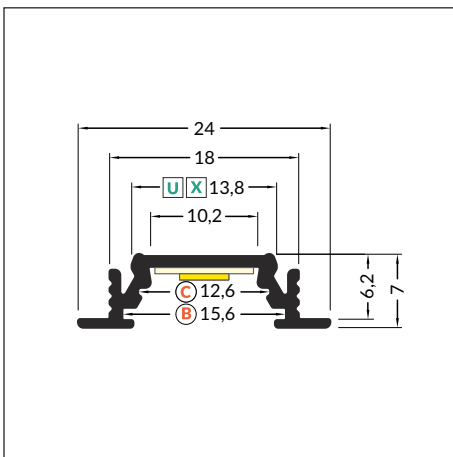
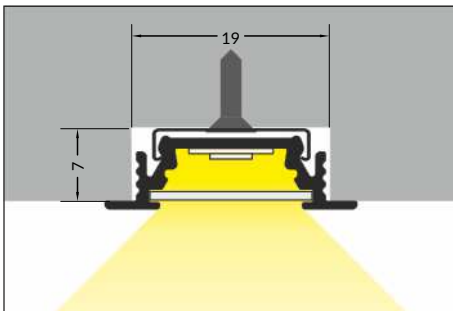
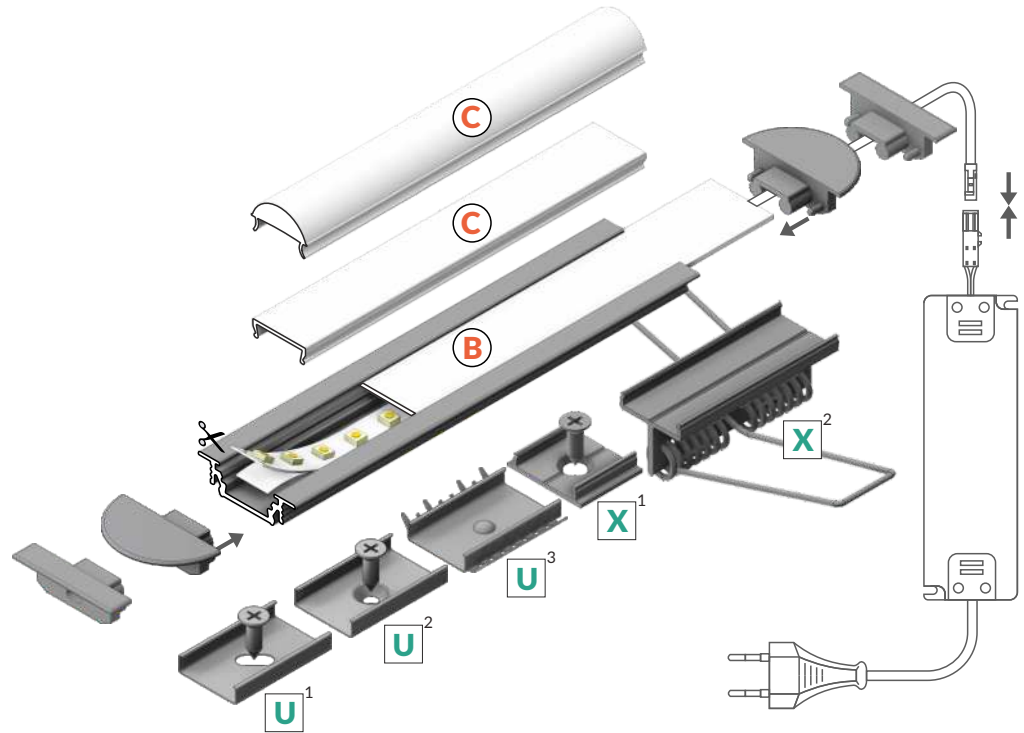

INDEX = 1 pc, length 2000 mm  
package > check the pricelist  
INDEKS = 1 szt., długość 2000 mm  
opakowanie > patrz cennik

white painted  
biały malowany  
**76210001**



anodized  
anodowany  
**76210020**



black anodized  
czarny anodowany  
**76210021**

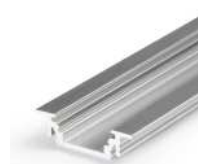

raw aluminium  
surowe aluminium  
**76210000**

 max 10 mm

 recessed  
wpustowy

Available lengths: 1000 mm, 2000 mm, 3000 mm, 4000 mm.  
The standard profile length tolerance is +20 mm.  
More details >> 1.08.

Dostępne długości: 1000 mm, 2000 mm, 3000 mm, 4000 mm.  
Standardowa tolerancja długości profili wynosi: +20 mm.  
Więcej informacji >> 1.08.



## COVERS / KLOSZE

### B slide cover

colours: transparent, frosted, opal  
material: PC, PP, PP

klosz B wsuwany  
kolory: transparentny, szron, mleczny  
materiał: PC, PP, PP

### C click cover

colours: transparent, opal  
material: PMMA

klosz C klik  
kolory: transparentny, mleczny  
materiał: PMMA

### C click cover lens

colour: transparent  
material: PC

klosz C klik soczewka  
kolor: transparentny  
materiał: PC



**Note!** Dimensions of the space needed to install LED source  
**Uwaga!** Wymiary przestrzeni do zamontowania źródła LED

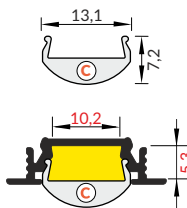
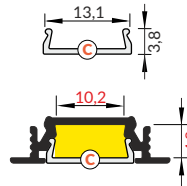
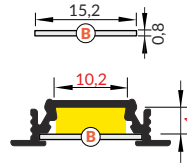

length 2000 mm  
package > check the pricelist  
długość 2000 mm  
opakowanie > patrz cennik

B transparent / B transparentny  
index = 10 pcs / indeks = 10 szt.

76250016

B frosted / B szron  
index = 10 pcs / indeks = 10 szt.

76250039

B opal / B mleczny  
index = 10 pcs / indeks = 10 szt.

76250038

C transparent / C transparentny  
index = 1 pc / indeks = 1 szt.

76330000

C opal / C mleczny  
index = 1 pc / indeks = 1 szt.

76330038

**NEW**



reel, length 20 m  
package > check the pricelist  
rolka, długość 20 m  
opakowanie > patrz cennik

C opal / C mleczny  
index = 1 pc / indeks = 1 szt.

76360038S



length 2000 mm  
package > check the pricelist  
długość 2000 mm  
opakowanie > patrz cennik

C lens / C soczewka  
index = 1 pc / indeks = 1 szt.

76300000

The standard cover length tolerance is +20 mm.  
More details >> 1.08.

Standardowa tolerancja długości kloszy wynosi: +20 mm  
Więcej informacji >> 1.08.

## MOUNTINGS / MOCOWANIA

### U flexible mounting plate

colour: inox  
material: stainless steel

uchwyt U sprężysty  
kolor: inox  
materiał: stal nierdzewna

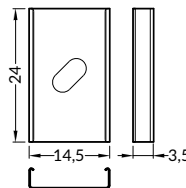
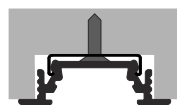

### cone U flexible mounting plate

colour: inox  
material: stainless steel

uchwyt U sprężysty cone  
kolor: inox  
materiał: stal nierdzewna

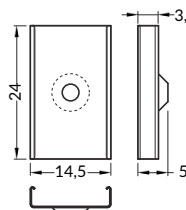
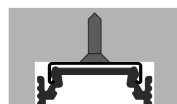

### rack U flexible mounting plate

colour: inox  
material: stainless steel

uchwyt U sprężysty rack  
kolor: inox  
materiał: stal nierdzewna

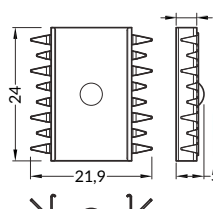

INDEX = 10 sets = 20 pcs  
package > check the pricelist  
INDEKS = 10 kpl = 20 szt.  
opakowanie > patrz cennik

inox  
76380000

inox  
76620000

inox  
76610019





**X mounting plate**  
colour: raw aluminium  
material: aluminium

uchwyt X  
kolor: surowe aluminium  
materiał: aluminium

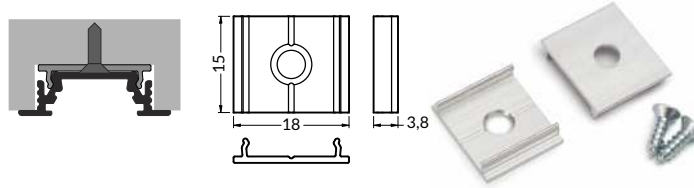

INDEX = 10 sets = 20 pcs  
package > check the pricelist  
INDEKS = 10 kpl = 20 szt.  
opakowanie > patrz cennik

raw aluminium  
surowe aluminium  
76260000

**spring X mounting plate**  
colour: raw aluminium  
material: aluminium

uchwyt X sprężyna  
kolor: surowe aluminium  
materiał: aluminium

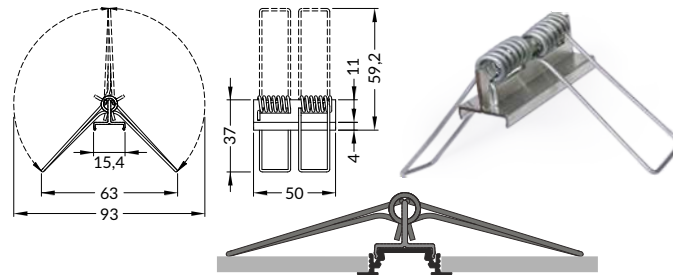

INDEX = 1 pc  
package > check the pricelist  
INDEKS = 1 szt.  
opakowanie > patrz cennik

raw aluminium  
surowe aluminium  
23130000

## ENDINGS / ZAŚLEPKI

**GROOVE10 ending gen2 with hole**  
colours: white, silver, black, grey  
material: ABS

zaślepka GROOVE10 gen2 z otworem  
kolory: biały, srebrny, czarny, szary  
materiał: ABS

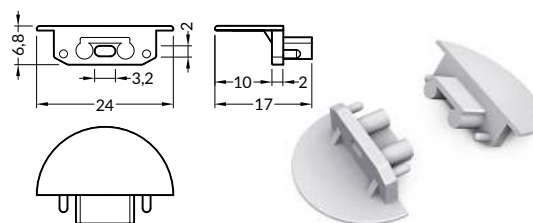

INDEX = 10 sets = 20 pcs  
package > check the pricelist  
INDEKS = 10 kpl = 20 szt.  
opakowanie > patrz cennik

white / biały  
76980001  
silver / srebrny  
76980040  
black / czarny  
76980002  
grey / szary  
76980022

**GROOVE10 ending gen2 SQ with hole**  
colours: white, silver, black, grey  
material: ABS

zaślepka GROOVE10 gen2 SQ z otworem  
kolory: biały, srebrny, czarny, szary  
materiał: ABS

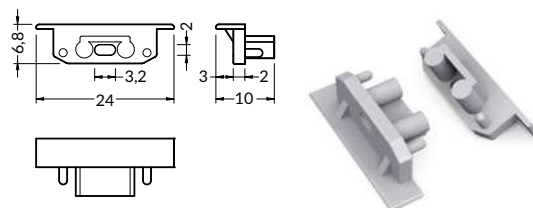

white / biały  
76990001  
silver / srebrny  
76990040  
black / czarny  
76990002  
grey / szary  
76990022

## CONNECTORS / ŁĄCZNIKI

**X connector 180 deg**  
colour: raw aluminium  
material: aluminium

łącznik X 180 st  
kolor: surowe aluminium  
materiał: aluminium

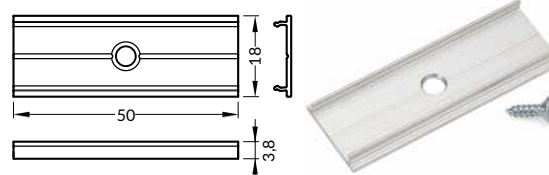

INDEX = 1 set  
package > check the pricelist  
INDEKS = 1 kpl  
opakowanie > patrz cennik

raw aluminium  
surowe aluminium  
76350000

**GROOVE10 connector 90 deg**  
colours: white, anodized, black  
material: aluminium

łącznik GROOVE10 90 st  
kolory: biały, anodowany, czarny  
materiał: aluminium

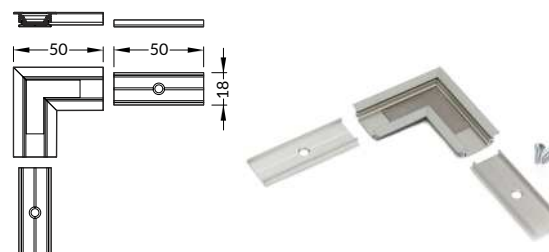

INDEX = 1 set  
package > check the pricelist  
INDEKS = 1 kpl  
opakowanie > patrz cennik

white painted  
biały malowany  
76530001  
anodized  
anodowany  
76530020  
black anodized  
czarny anodowany  
76530021

