

# SURFACE10 BC/UX

## ALUMINIUM SURFACE PROFILE

### ALUMINIOWY PROFIL NAWIERZCHNIOWY

- hidden mounting
- wide range of accessories, 6 types of covers
- maximum LED strip width: 10 mm
  
- ukryte mocowanie
- szeroki wybór akcesoriów, 6 rodzajów kloszy
- maksymalna szerokość taśmy LED: 10 mm

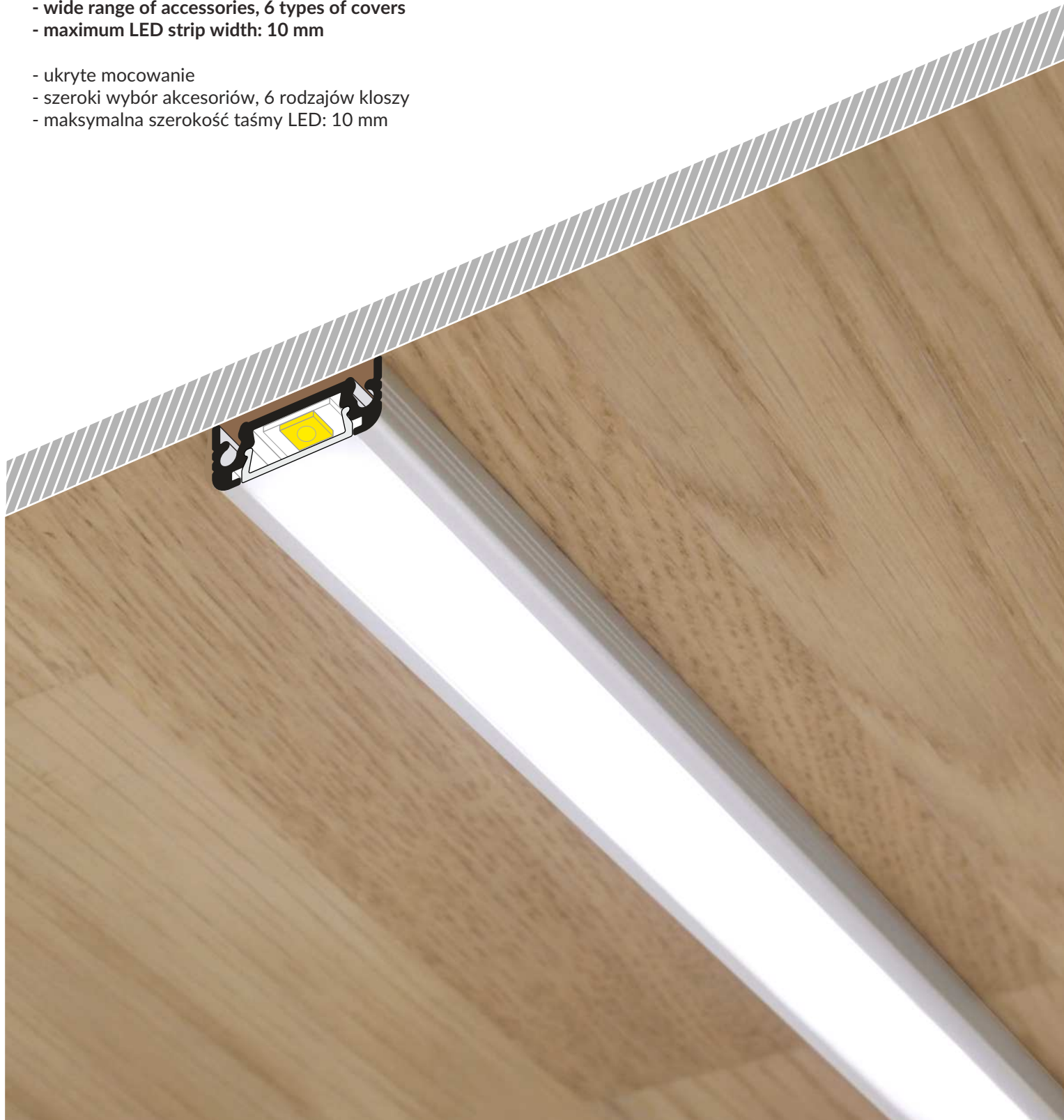

## SIMILAR IN THE OFFER / PODOBNE W OFERCIE



SLIM8  
AC2/Z



SMART10  
AC2/Z



BEGTON12  
J/S



SURFACE14  
EF/TY



LINEA20  
EF/TY



WIDE24  
G/W



**B** slide cover  
klosz B wsuwany

**C** click cover  
klosz C klik

**C** lens cover  
klosz C soczewka

**U**<sup>1</sup> U flexible mounting plate  
uchwyt U sprężysty

**U**<sup>2</sup> cone U flexible mounting plate  
uchwyt U sprężysty cone

**X**<sup>1</sup> X mounting plate  
uchwyt X

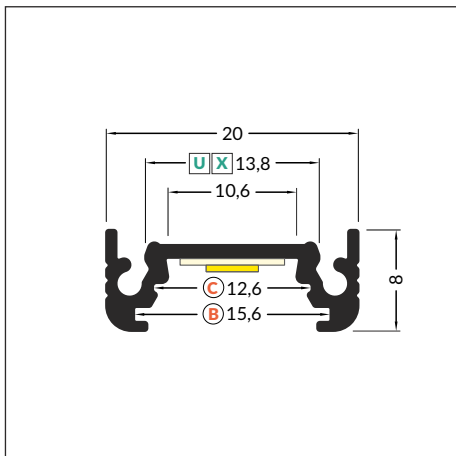
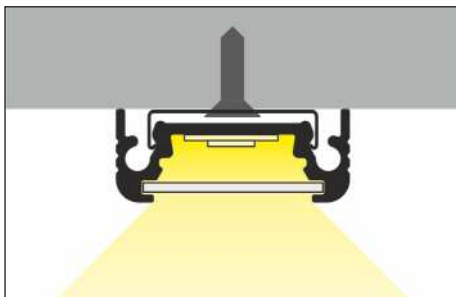
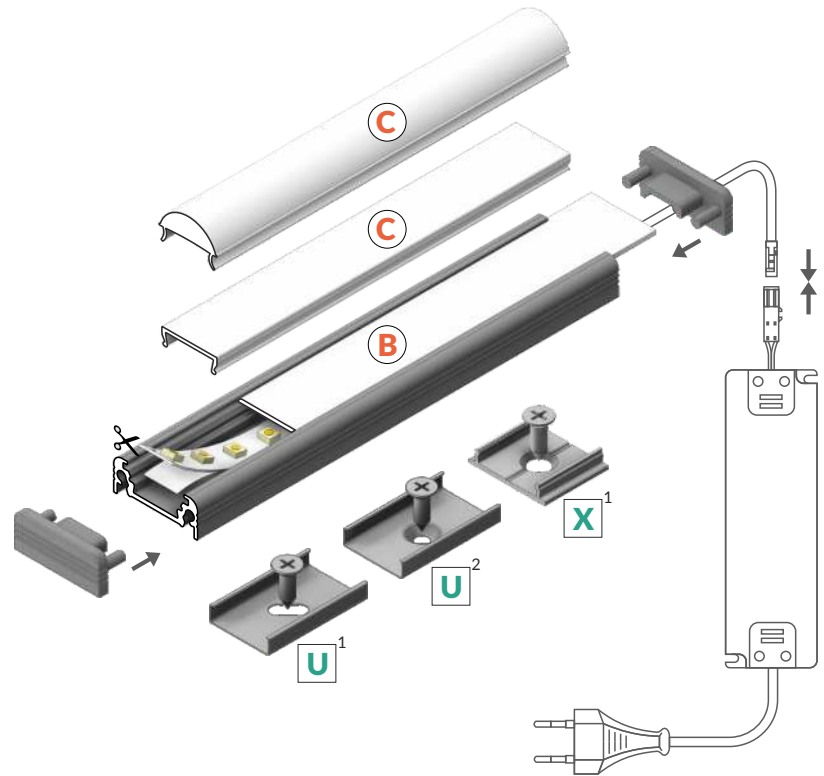

 max 10 mm

 surface  
nawierzchniowy



INDEX = 1 pc, length 2000 mm  
package > check the pricelist  
INDEKS = 1 szt., długość 2000 mm  
opakowanie > patrz cennik

white painted  
biały malowany  
77270001



anodized  
anodowany  
77270020



black anodized  
czarny anodowany  
77270021



raw aluminium  
surowe aluminium  
77270000

Available lengths: 1000 mm, 2000 mm, 3000 mm, 4000 mm.  
The standard profile length tolerance is +20 mm.  
More details >> 1.08.

Dostępne długości: 1000 mm, 2000 mm, 3000 mm, 4000 mm.  
Standardowa tolerancja długości profili wynosi: +20 mm.  
Więcej informacji >> 1.08.



## COVERS / KLOSZE

### B slide cover

colours: transparent, frosted, opal  
material: PC, PP, PP

klosz B wsuwany  
kolory: transparentny, szron, mleczny  
materiał: PC, PP, PP

### C click cover

colours: transparent, opal  
material: PMMA

klosz C klik  
kolory: transparentny, mleczny  
materiał: PMMA

C click cover lens  
colour: transparent  
material: PC

klosz C klik soczewka  
kolor: transparentny  
materiał: PC



**Note!** Dimensions of the space to install LED source  
**Uwaga!** Wymiary przestrzeni do zamontowania źródła LED

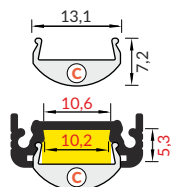
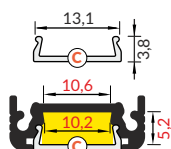
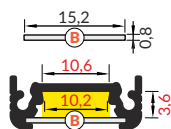

length 2000 mm  
package > check the pricelist  
długość 2000 mm  
opakowanie > patrz cennik

B transparent / B transparentny  
index = 10 pcs / indeks = 10 szt.  
**76250016**

B frosted / B szron  
index = 10 pcs / indeks = 10 szt.  
**76250039**

B opal / B mleczny  
index = 10 pcs / indeks = 10 szt.  
**76250038**

C transparent / C transparentny  
index = 1 pc / indeks = 1 szt.  
**76330000**

C opal / C mleczny  
index = 1 pc / indeks = 1 szt.  
**76330038**

**NEW**



reel, length 20 m  
package > check the pricelist  
rolka, długość 20 m  
opakowanie > patrz cennik

C opal / C mleczny  
index = 1 pc / indeks = 1 szt.  
**76360038S**



length 2000 mm  
package > check the pricelist  
długość 2000 mm  
opakowanie > patrz cennik

C lens / C soczewka  
index = 1 pc / indeks = 1 szt.  
**76300000**

The standard cover length tolerance is +20 mm.  
More details >> 1.08.  
Standardowa tolerancja długości kloszy wynosi: +20 mm  
Więcej informacji >> 1.08.

## MOUNTINGS / MOCOWANIA

### U flexible mounting plate

colours: inox  
material: stainless steel

uchwyt U sprężysty  
kolory: inox  
materiał: stal nierdzewna

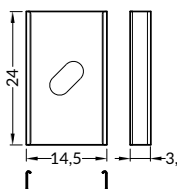
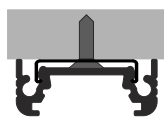

### cone U flexible mounting plate

colours: inox  
material: stainless steel

uchwyt U sprężysty cone  
kolory: inox  
materiał: stal nierdzewna

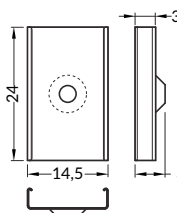
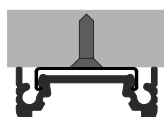

### X mounting plate

colours: raw aluminium  
material: aluminium

uchwyt X  
kolory: surowe aluminium  
materiał: aluminium

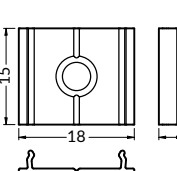
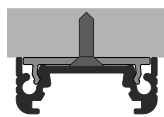

INDEX = 10 sets = 20 pcs  
package > check the pricelist  
INDEKS = 10 kpl = 20 szt.  
opakowanie > patrz cennik

inox  
**76380000**

inox  
**76620000**

raw aluminium  
surowe aluminium  
**76260000**



## SURFACE10 simple holder

material: zinc coated  
uchwyt SURFACE10 prosty  
material: stal ocynkowana

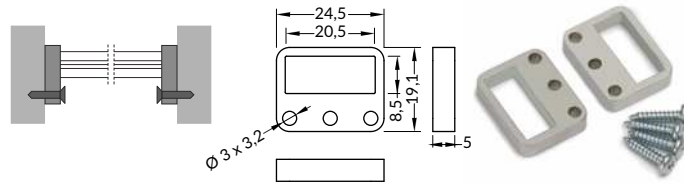

INDEX = 1 set = 2 pcs  
package > check the pricelist  
INDEKS = 1 kpl = 2 szt.  
opakowanie > patrz cennik

zinc coated  
stal ocynkowana  
77370030

## ENDINGS / ZAŚLEPKI

### SURFACE10 ending gen2

colours: white, silver, black, grey  
material: ABS

zaślepka SURFACE10 gen2  
kolory: biały, srebrny, czarny, szary  
material: ABS

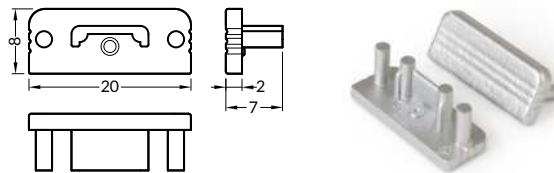

INDEX = 10 sets = 20 pcs  
package > check the pricelist  
INDEKS = 10 kpl = 20 szt.  
opakowanie > patrz cennik

white / biały  
77990001  
silver / srebrny  
77990040  
black / czarny  
77990002  
grey / szary  
77990022

### SURFACE10 ending gen2 with hole

colours: white, silver, black, grey  
material: ABS

zaślepka SURFACE10 gen2 z otworem  
kolory: biały, srebrny, czarny, szary  
material: ABS

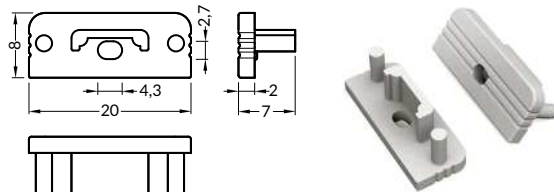

white / biały  
77980001  
silver / srebrny  
77980040  
black / czarny  
77980002  
grey / szary  
77980022

## CONNECTORS / ŁĄCZNIKI

### X connector 180 deg

colour: inox  
material: aluminium

łącznik X 180 st  
kolor: inox  
material: aluminium

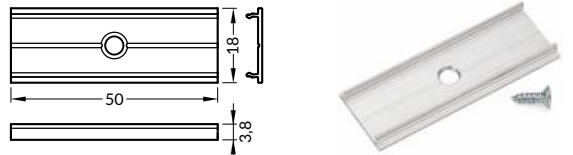

INDEX = 1 set,  
package > check the pricelist  
INDEKS = 1 kpl.,  
opakowanie > patrz cennik

raw aluminium  
surowe aluminium  
76350000

### SURFACE10 connector 90 deg

colours: white, anodized, black  
material: aluminium

łącznik SURFACE10 90 st  
kolory: biały, anodowany, czarny  
material: aluminium

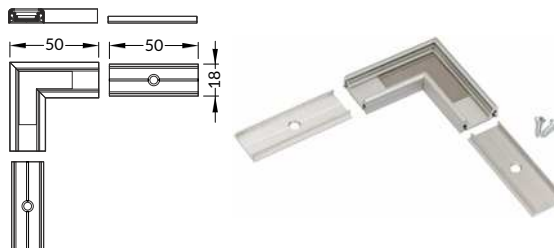

white painted  
biały malowany  
77410001

anodized  
anodowany  
77410020

black anodized  
czarny anodowany  
77410021

