



WIDE24 G/W

WIDE, ALUMINIUM, SURFACE PROFILE

SZEROKI, ALUMINIOWY PROFIL NAWIERZCHNIOWY



- lighting and decorative profile
- possibility of installing 3 8 mm LED strips
- Slick socket
- maximum LED strip width: 24 mm
- profil oświetleniowo-dekoracyjny
- możliwość zastosowania równoległe 3 taśm 8 mm
- gniazdo z funkcją Slick
- maksymalna szerokość taśmy LED: 24 mm



SIMILAR IN THE OFFER / PODOBNE W OFERCIE

SURFACE10
BC/UX

UNI12
BCD/U

BEGTON12
J/S

SURFACE14
EF/TY

LINEA20
EF/TY

VARIO30-02
ACD-9/TY



VARIO30-01
ACD-9/TY

 TOPMET®

WIDE24 G/W

G slide cover
klosz G wsuwany

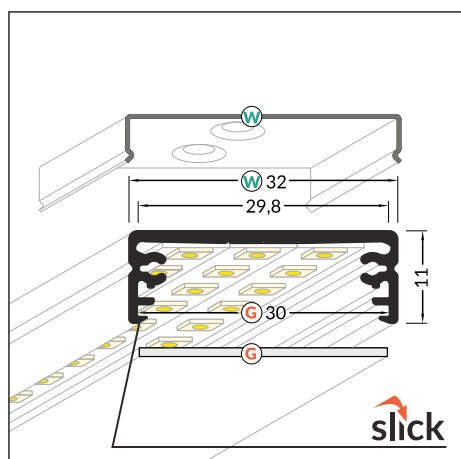
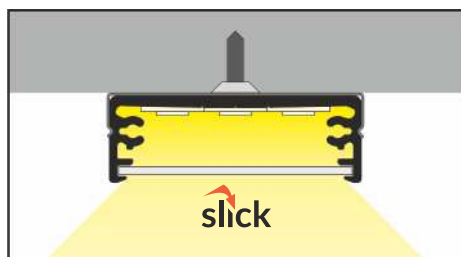
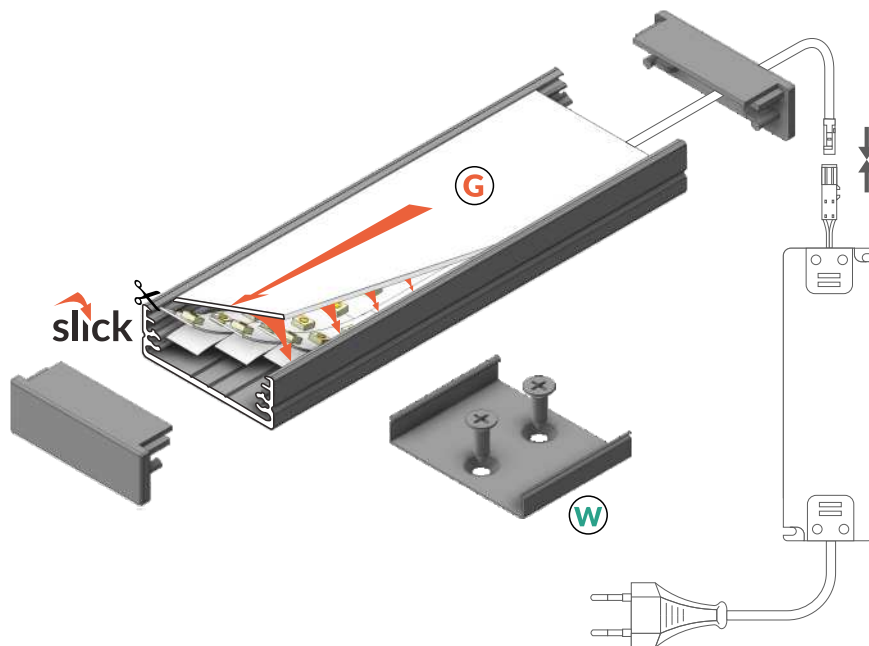
W cone W flexible mounting plate
uchwyt W sprężysty cone



 max 24 mm

 surface
nawierzchniowy



 white painted
biały malowany
84030001



 anodized
anodowany
84030020



 black anodized
czarny anodowany
84030021



 raw aluminium
surowe aluminium
84030000

INDEX = 1 pc, length 2000 mm
package = 10 pcs
INDEKS = 1 szt., długość 2000 mm
opakowanie = 10 szt.

Available lengths / Dostępne długości
1000 mm, 2000 mm, 3000 mm, 4000 mm



COVERS / KLOSZE

G slide cover
colours: transparent, frosted, white
material: PC, PP, PP

klosz **G** wsuwany
kolory: transparentny, szron, mleczny
materiał: PC, PP, PP



Note! Dimensions of the space to install LED source
Uwaga! Wymiary przestrzeni do zamontowania źródła LED

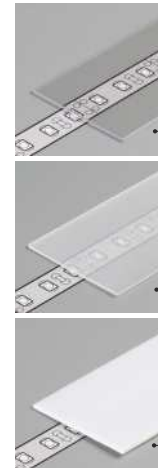
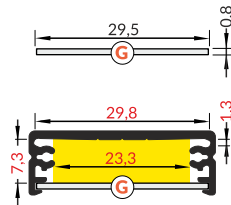

INDEX = 1 pc, length 2000 mm
package = 10 pcs
INDEKS = 1 szt., długość 2000 mm
opakowanie = 10 szt.

G transparent / G transparentny
84070016

G frosted / G szron
84070039

G white / G mleczny
84070038

ENDINGS / ZAŚLEPKI

WIDE24 ending
colours: white, silver, black, grey
material: ABS
zaślepka WIDE24
kolory: biały, srebrny, czarny, szary
materiał: ABS

WIDE24 ending with hole
colours: white, silver, black, grey
material: ABS
zaślepka WIDE24 z otworem
kolory: szary, czarny, biały, srebrny
materiał: ABS

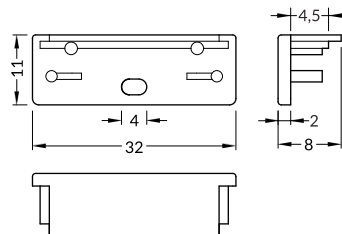

INDEX = 1 set
package of 10 sets = 20 pcs
INDEKS = 1 komplet, opakowanie
zawiera 10 kompletów = 20 szt.

white
białe
with hole z otworem
84300001 | without hole bez otworu
84040001

silver
srebrne
with hole z otworem
84300040 | without hole bez otworu
84040040

black
czarne
with hole z otworem
84300002 | without hole bez otworu
84040002

grey
szare
with hole z otworem
84300022 | without hole bez otworu
84040022

MOUNTINGS / MOCOWANIA

cone W flexible mounting plate
colour: inox
material: stainless steel

uchwyt **W** sprężysty cone
kolor: inox
materiał: stal nierdzewna

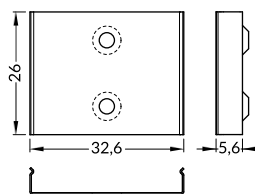
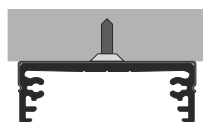

INDEX = 1 set
package of 10 sets = 20 pcs
INDEKS = 1 komplet
opakowanie zawiera 10 kpl = 20 szt.

cone **W** flexible mounting plate
uchwyt **W** sprężysty cone

white painted
biały malowany 84510001

inox
inox 84510019

black painted
czarny malowany 84510002

WIDE24 simple holder
material: zinc coated steel

uchwyt WIDE24 prosty
materiał: stal ocynkowana

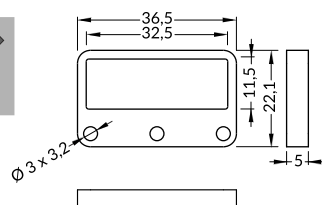
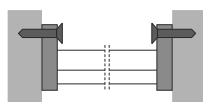

INDEX = 1 set = 2 pcs
INDEKS = 1 komplet = 2 szt.

simple holder
uchwyt prosty

zinc coated
stal ocynkowana
84220030



SLING / ZAWIESIE

SELV sling 50 V 1500
colours: white, silver, black

zawiesie SELV 50 V 1500
kolory: biały, srebrny, czarny

sling for LED mounting 1500
colour: chrome

zawiesie do uchwytu LED 1500
kolor: chrom



INDEX = 1 set
INDEKS = 1 zestaw

SELV sling 50 V 1500
zawiesie SELV 50 V 1500

-  white
biały 67120001
-  silver
srebrny 67120022
-  black
czarny 67120002

sling for LED mounting 1500
zawiesie do uchwytu LED 1500

-  chrome
chrom 67140003



PL

Made in Poland
Wyprodukowane w Polsce



EU-registered industrial design
Wzory przemysłowe EU

TOPMET LIGHT Kłósowicz Wiśniewski i Wspólnik Sp. j. ADDRESS: Ostrowska 354, 61-312 Poznań, POLAND
tel. +48 61 87 27 500, fax. +48 61 87 27 518 biuro@topmet.pl, www.topmet.pl

The catalogue is not an offer under Polish Civil Code regulations. Colours of particular products may vary slightly from colours shown in pictures. The dimensions given are approximate and can not be a reason for complaint. TOPMET Company reserves the right to make technical changes.
Folder nie stanowi oferty w myśl przepisów Kodeksu Cywilnego. Aktualną ofertę firmy stanowi cennik. Kolory poszczególnych produktów mogą się nieznacznie różnić od kolorów prezentowanych na zdjęciach. Podane wymiary są wymiarami orientacyjnymi i nie mogą stanowić podstawy reklamacji. Firma TOPMET zastrzega sobie prawo do wprowadzania zmian technicznych.

brochure designer • proj. folderu: M. Kędziora, A. Szafran 11.2016. photo • fot. K. Samulski, A. Szafran, L. Wesołowski