



# CORNER27 G/UX

## LARGE-SIZE ANGULAR PROFILE

### WIELKOGABARYTOWY PROFIL KĄTOWY

- lighting profile - possibility of high lumen output
- hidden mounting
- two lighting angles: 30° or 60°
- maximum LED strip width: 27 mm or 3 standard strips (8 mm)
- profil oświetleniowy - możliwość uzyskania dużej wydajności
- ukryte mocowanie
- dwa kąty świecenia: 30 i 60°
- maksymalna szerokość taśmy LED: 27 mm albo do 3 taśm standardowych (8 mm)

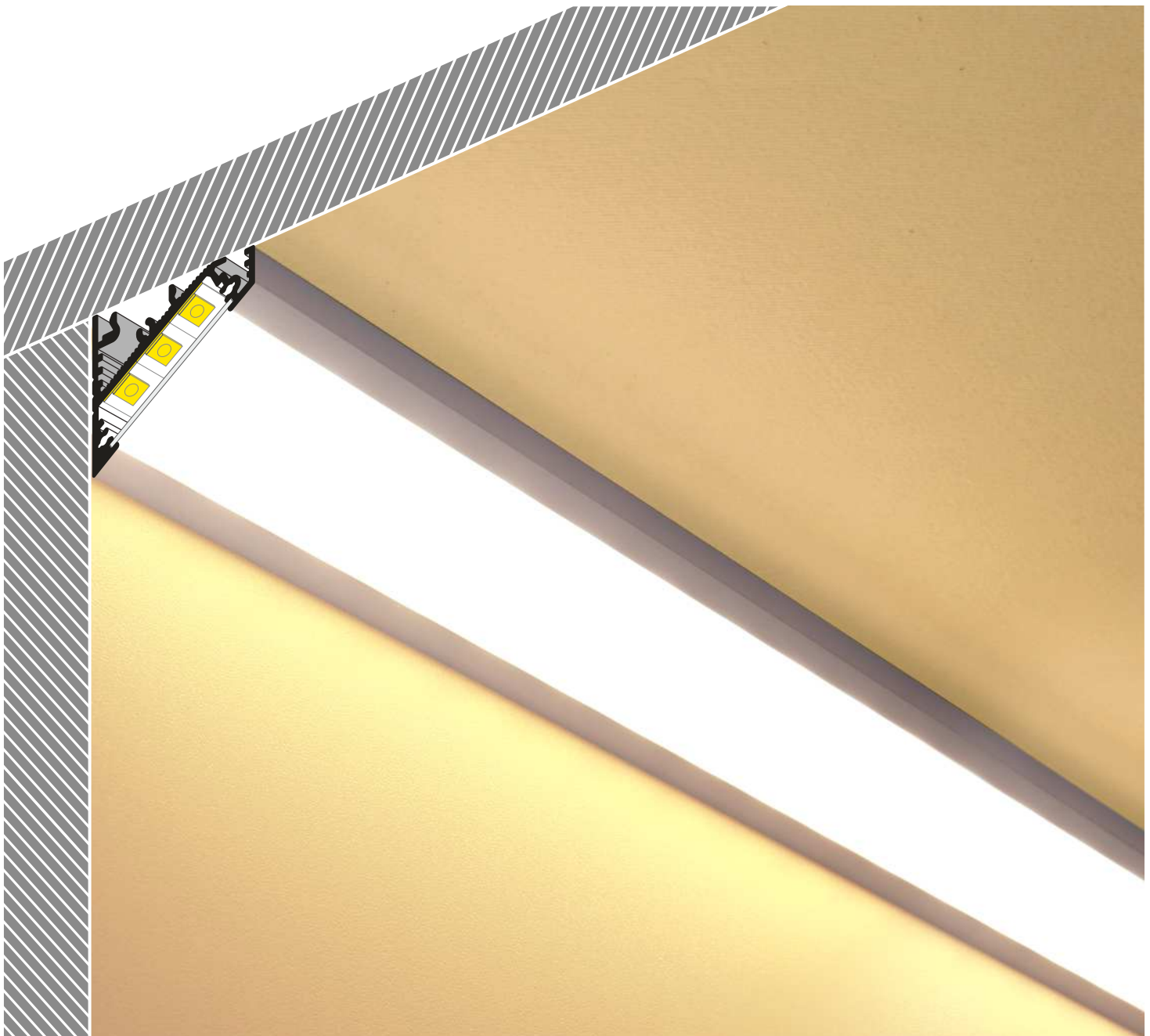

## SIMILAR IN THE OFFER / PODOBNE W OFERCIE



TRIO10  
BC



CORNER10  
BC/UX



QUARTER10  
BD/U6



CABI12  
E



CORNER14  
EF/TY



# CORNER27 G/UX

- G** slide cover  
klosz G wsuwany
- U<sup>1</sup>** U flexible mounting plate  
uchwyt U sprężysty
- U<sup>2</sup>** cone U flexible mounting plate  
uchwyt U sprężysty cone
- X<sup>1</sup>** X mounting plate  
uchwyt X

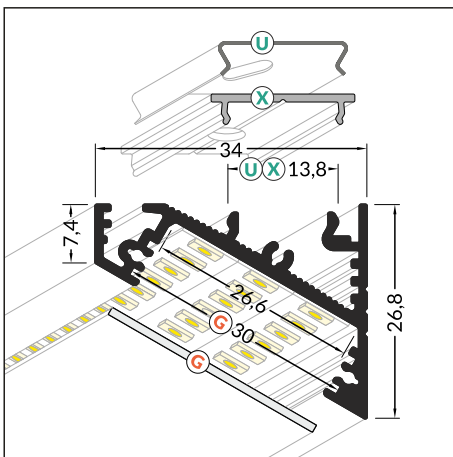
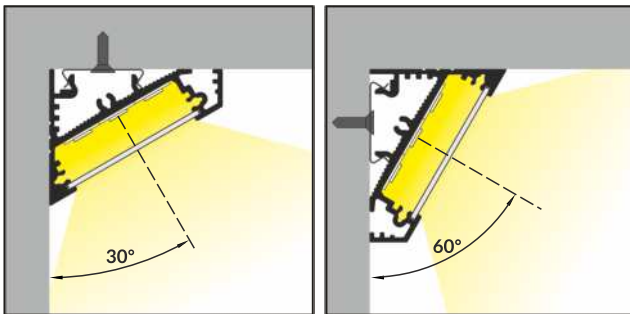
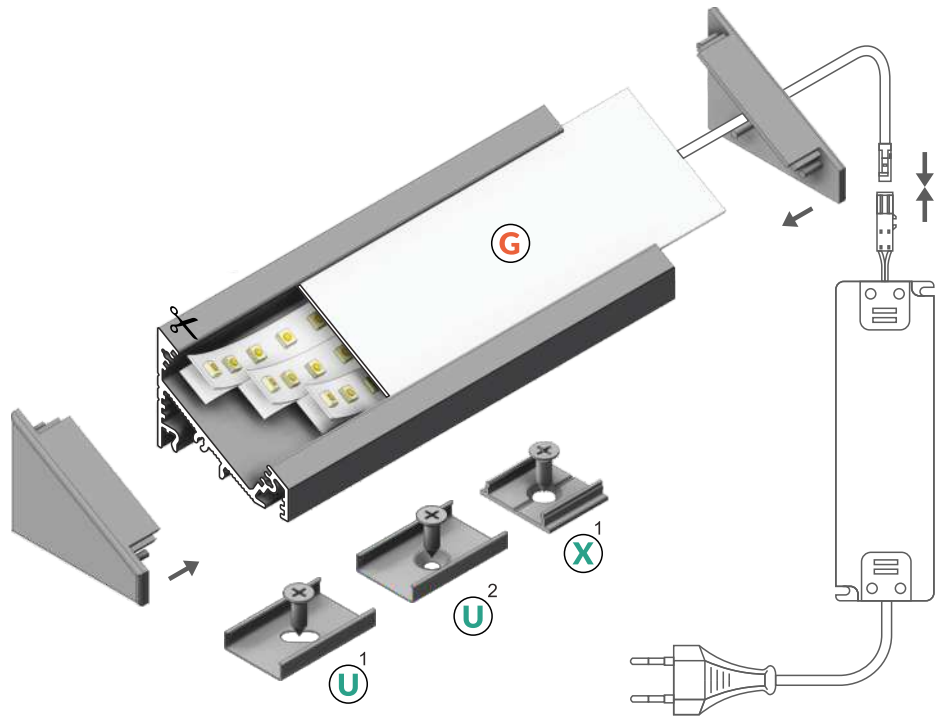

INDEX = 1 pc, length 2000 mm  
package = 10 pcs  
INDEKS = 1 szt., długość 2000 mm  
opakowanie = 10 szt.

 white painted  
biały malowany  
98030001

 anodized  
anodowany  
98030020

 black anodized  
czarny anodowany  
98030021

Available lengths / Dostępne długości  
1000 mm, 2000 mm, 3000 mm, 4000 mm

 max 27 mm

 corner  
kątowy



## COVERS / KLOSZE

### G slide cover

colours: transparent, frosted, white  
material: PC, PP, PP

klosz G wsuwany  
kolory: transparentny, szron, mleczny  
materiał: PC, PP, PP



**Note!** Dimensions of the space to install LED source  
**Uwaga!** Wymiary przestrzeni do zamontowania źródła LED

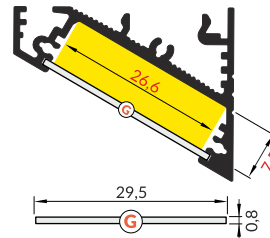

INDEX = 1 pc, length 2000 mm  
package = 10 pcs  
INDEKS = 1 szt., długość 2000 mm  
opakowanie = 10 szt.

G transparent / G transparentny  
84070016

G frosted / G szron  
84070039

G white / G mleczny  
84070038

## ENDINGS / ZAŚLEPKI

### CORNER27 ending

colours: white, silver, black, grey  
material: ABS

zaślepka CORNER27  
kolory: biały, srebrny, czarny, szary  
materiał: ABS

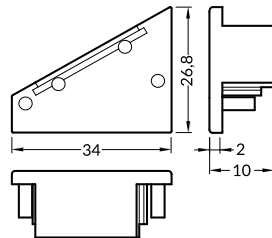

INDEX = 1 set,  
package of 10 sets = 20 pcs  
INDEKS = 1 komplet, opakowanie  
zawiera 10 kompletów = 20 szt.

white  
białe 98050001

silver  
srebrne 98050040

black  
czarne 98050002

grey  
szare 98050022

## MOUNTINGS / MOCOWANIA

### U flexible mounting plate

colour: inox  
material: stainless steel

uchwyt U sprężysty  
kolor: inox  
materiał: stal nierdzewna

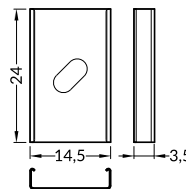
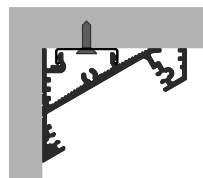

INDEX = 1 set  
package of 10 sets = 20 pcs  
INDEKS = 1 komplet  
opakowanie zawiera 10 kpl = 20 szt

U flexible mounting plate  
uchwyt U sprężysty

inox  
inox 76380000

### cone U flexible mounting plate

colour: inox  
material: stainless steel

uchwyt U sprężysty cone  
kolor: inox  
materiał: stal nierdzewna

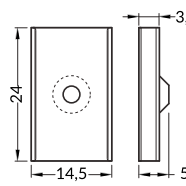
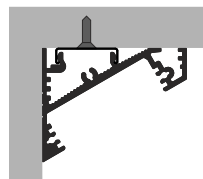

cone U flexible mounting plate  
uchwyt U sprężysty cone

inox  
inox 76620000

### X mounting plate

colour: raw aluminium  
material: aluminium

uchwyt X  
kolor: surowe aluminium  
materiał: aluminium

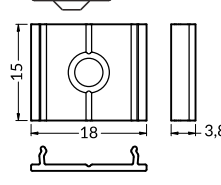
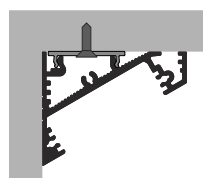

X mounting plate  
uchwyt X

raw aluminium  
surowe aluminium 76260000

## CONNECTORS / ŁĄCZNIKI

### X connector

colour: raw aluminium  
material: aluminium

łącznik X  
kolor: surowe aluminium  
materiał: aluminium

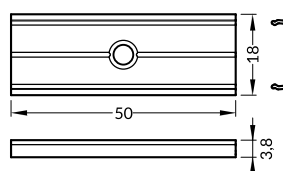

INDEX = 1 set  
INDEKS = 1 komplet

raw aluminium  
surowe aluminium 76350000



Made in Poland  
Wyprodukowane w Polsce



EU-registered industrial design  
Wzory przemysłowe EU

TOPMET LIGHT Kłosowicz Wiśniewski i Wspólnik Sp. j. ADDRESS: Ostrowska 354, 61-312 Poznań, POLAND  
tel. +48 61 87 27 500, fax. +48 61 87 27 518 [biuro@topmet.pl](mailto:biuro@topmet.pl), [www.topmet.pl](http://www.topmet.pl)

The catalogue is not an offer under Polish Civil Code regulations. Colours of particular products may vary slightly from colours shown in pictures. The dimensions given are approximate and can not be a reason for complaint. TOPMET Company reserves the right to make technical changes.  
Folder nie stanowi oferty w myśl przepisów Kodeksu Cywilnego. Aktualną ofertę firmy stanowi cennik. Kolory poszczególnych produktów mogą się nieznacznie różnić od kolorów prezentowanych na zdjęciach. Podane wymiary są wymiarami orientacyjnymi i nie mogą stanowić podstawy reklamacji. Firma TOPMET zastrzega sobie prawo do wprowadzania zmian technicznych.

brochure designer • proj. folderu: M. Kędziora, A. Szafran 11.2016. photo • fot. A. Szafran, A. Wierdak, L. Wesolowski

 **TOPMET**®