

4 Channel Constant Voltage Waterproof DMX512 & RDM Decoder

Model No.: D4-WPS

IP67 waterproof/RDM/Stand-alone function/Seven PWM frequency/Linear or logarithmic dimming/Numeric display

Features

- Waterproof DMX512 decoder with IP67 rating, suitable for outdoor and damp environment.
- Comply with the DMX512/RDM standard protocols.
- Digital numeric display, set DMX decode start address by buttons.
- 1/2/4 DMX channel output selectable.
- 16bit (65536 levels) /8bit (256 levels) grey level selectable.
- PWM frequency 250/500/1000/2000/4000/8000/16000Hz selectable.
- Logarithmic or linear dimming curve selectable.
- Stand-alone RGB/RGBW mode and 4 channel dimmer mode selectable, which be controlled by buttons with built-in programs, instead of DMX signal.
- Over-heat / Over-load / Short circuit protection, recover automatically.

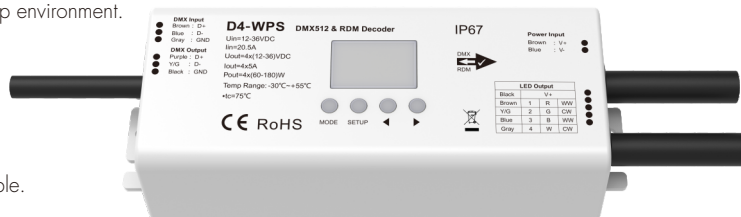

CE RoHS emc LVD

Technical Parameters

Input and Output		Safety and EMC		Warranty and Protection	
Input voltage	12-36VDC	EMC standard (EMC)	ETSI EN 301 489-1 V2.2.3 ETSI EN 301 489-17 V3.2.4	Warranty	5 years
Input current	20.5A	Safety standard(LVD)	EN 62368-1:2020+A11:2020	Protection	Reverse Polarity Over-heat Over-load Short circuit
Output voltage	4 x (12-36)VDC	Certification	CE,EMC,LVD	Environment	
Output current	4CH,5A/CH	Package		Operation temperature	Ta: -30°C ~ +55°C
Output power	4 x (60-180)W	Size	L165 x W98 x H72mm	Case temperature (Max.)	Tc:+75°C
Output type	Constant voltage	Gross weight	0.492kg	IP rating	IP67

Mechanical Structures and Installations

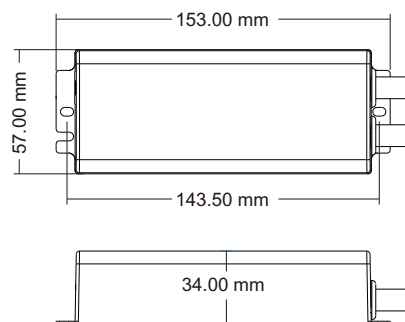
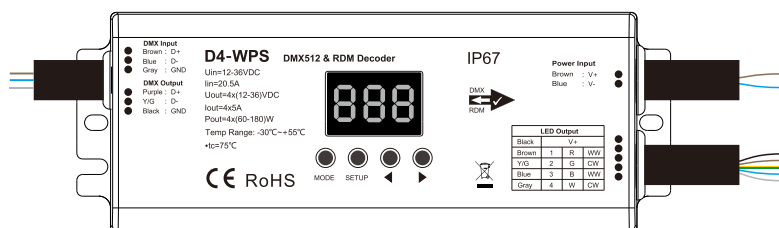

Wiring Diagram

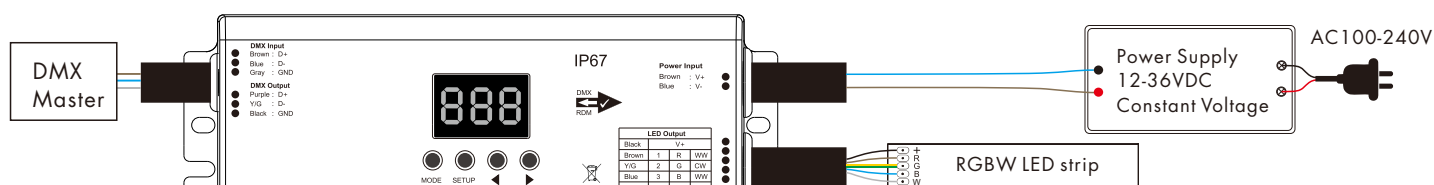

Note:

- An DMX signal amplifier is needed if more than 32 decoders are connected, or use overlong signal line, signal amplification should not be more than 5 times continuously.
- If the recoil effect occurs because of longer signal line or bad line quality, please try to connect 0.25W 90-120Ω terminal resistor at the end of each DMX signal line.
- When display 1OL,2OL,3OL,4OL, correspond to 1,2,3,4, channel overload alarm. When display OHA, overheat alarm.

Operation

System parameter setting

- Long press SETUP key for 2s, prepare for setup system parameter: decode mode, grey level, output PWM frequency, output brightness curve, default output level, automatic blank screen. then short press SETUP key to switch six item.
- Decode mode: short press ◀ or ▶ key to switch 1/2/4 channel decode mode("d-1", "d-2" or "d-4"). When set as 1 channel decode, the decoder occupy only 1 DMX address, and four channel output the same brightness of this DMX address.
- Grey level: short press ◀ or ▶ key to switch 8bit("b08") or 16 bit("b16"). choose 16 bit if the DMX master support 16 bit.
- Output PWM frequency: short press ◀ or ▶ key to switch 250Hz("F02"), 500Hz("F05"), 1000Hz("F10"), 2000Hz("F20"), 4000Hz("F40"), 8000Hz("F80") or 16000Hz("F16"). Higher PWM frequency, will cause lower output current, higher power noise, but more suitable for camera(No flickers for video).
- Output brightness curve: short press ◀ or ▶ key to switch linear curve("C-L") or logarithmic curve("C-E").
- Default output level: press ◀ or ▶ key to change default 0-100% level ("d00" to "dFF") when no DMX input signal.
- Automatic blank screen: short press ◀ or ▶ key to switch enable ("bon") or disable("boF") automatic blank screen.
- Long press SETUP key for 2s or timeout 10s, quit system parameter setting.

DMX mode

- Short press MODE key, when display 001~512, enter DMX mode.
- Press ◀ or ▶ key to change DMX decode start address(001~512), long press for fast adjustment.
- If there is a DMX signal input, will enter DMX mode automatically.
- DMX Dimming: Each D4-WPS DMX decoder occupy 4 DMX address when connecting the DMX console.
For example, the defaulted start address is 1, their corresponding relationship in the form:

DMX Console	DMX Decoder Output
CH1 0-255	CH1 PWM 0-100% (LED R)
CH2 0-255	CH2 PWM 0-100% (LED G)
CH3 0-255	CH3 PWM 0-100% (LED B)
CH4 0-255	CH4 PWM 0-100% (LED W)



DMX mode
(001~512)

Stand-alone RGB/RGBW mode

- Enter stand-alone RGB/RGBW mode only when DMX signal is disconnected or lost.
- Short press MODE key, when display P01~P30, enter stand-alone RGB/RGBW mode.
- Press ◀ or ▶ key to change dynamic mode number(P01~P30).
- Each mode can adjust speed and brightness.
Short press SETUP key for switch between mode speed, brightness and W channel brightness setting.
Press ◀ or ▶ key to setup value of each item.
Mode speed: 1-10 level speed(S-1, S-9, S-F).
Mode brightness: 1-10 level brightness(b-1, b-9, b-F).
W channel brightness: 0-255 level brightness(400-4FF).
Long press SETUP key for 2s, or timeout 10s, quit setting.



Stand-alone RGB/RGBW mode
(P01~P30)

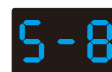

Speed
(8 level)

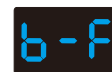

Brightness
(10 level, 100%)

Stand-alone dimmer mode

- Enter stand-alone dimmer mode only when DMX signal is disconnected or lost.
- Short press MODE key, when display L-1~L-8, enter stand-alone dimmer mode.
- Press ◀ or ▶ key to change dimmer mode number(L-1~L-8).
- Each dimmer mode can adjust each channel brightness independently.
Short press SETUP key to switch between 4 channel(100~1FF, 200~2FF, 300~3FF, 400~4FF).
Press ◀ or ▶ key to setup brightness value of each channel.
Long press SETUP key for 2s, or timeout 10s, quit setting.



Stand-alone dimmer mode
(L-1~L-8)

Restore factory default parameter

- Long press ◀ and ▶ key for 2s, restore factory default parameter, display "RES".
- Factory default parameter: DMX decode mode, DMX decode start address is 1, four channel decode, 8 bit grey level, 2000Hz PWM frequency output, logarithmic brightness curve, output 100% level when no DMX input, RGB mode number is 1, dimmer mode number is 1, disable automatic blank screen.

RGB change mode list

No.	Name	No.	Name	No.	Name
P01	Static red	P11	Green strobe	P21	Red yellow smooth
P02	Static green	P12	Blue strobe	P22	Green cyan smooth
P03	Static blue	P13	White strobe	P23	Blue purple smooth
P04	Static yellow	P14	RGB strobe	P24	Blue white smooth
P05	Static cyan	P15	7 color strobe	P25	RGB+W smooth
P06	Static purple	P16	Red fade in and out	P26	RGBW smooth
P07	Static white	P17	Green fade in and out	P27	RGBY smooth
P08	RGB jump	P18	Blue fade in and out	P28	Yellow cyan purple smooth
P09	7 color jump	P19	White fade in and out	P29	RGB smooth
P10	Red strobe	P20	RGBW fade in and out	P30	6 color smooth

Dimming curve setting

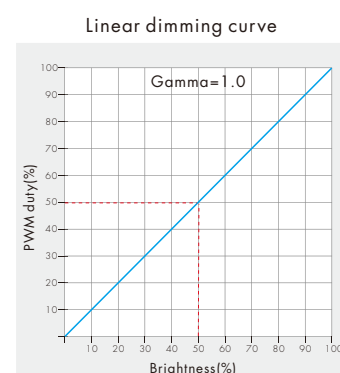

Malfunctions analysis & troubleshooting

Malfunctions	Causes	Troubleshooting
No light	1. No power. 2. Wrong connection or insecure.	1. Check the power. 2. Check the connection.
Wrong color	1. Wrong connection of R/G/B/W wires. 2. DMX decode address error.	1. Reconnect R/G/B/W wires. 2. Set correct decode address.
Uneven intensity between front and rear, with voltage drop	1. Output cable is too long. 2. Wire diameter is too small. 3. Overload beyond power supply capability. 4. Overload beyond controller capability.	1. Reduce cable or loop supply. 2. Change wider wire. 3. Replace higher power supply. 4. Add power repeater.

